

FiTech

Fuel Injection

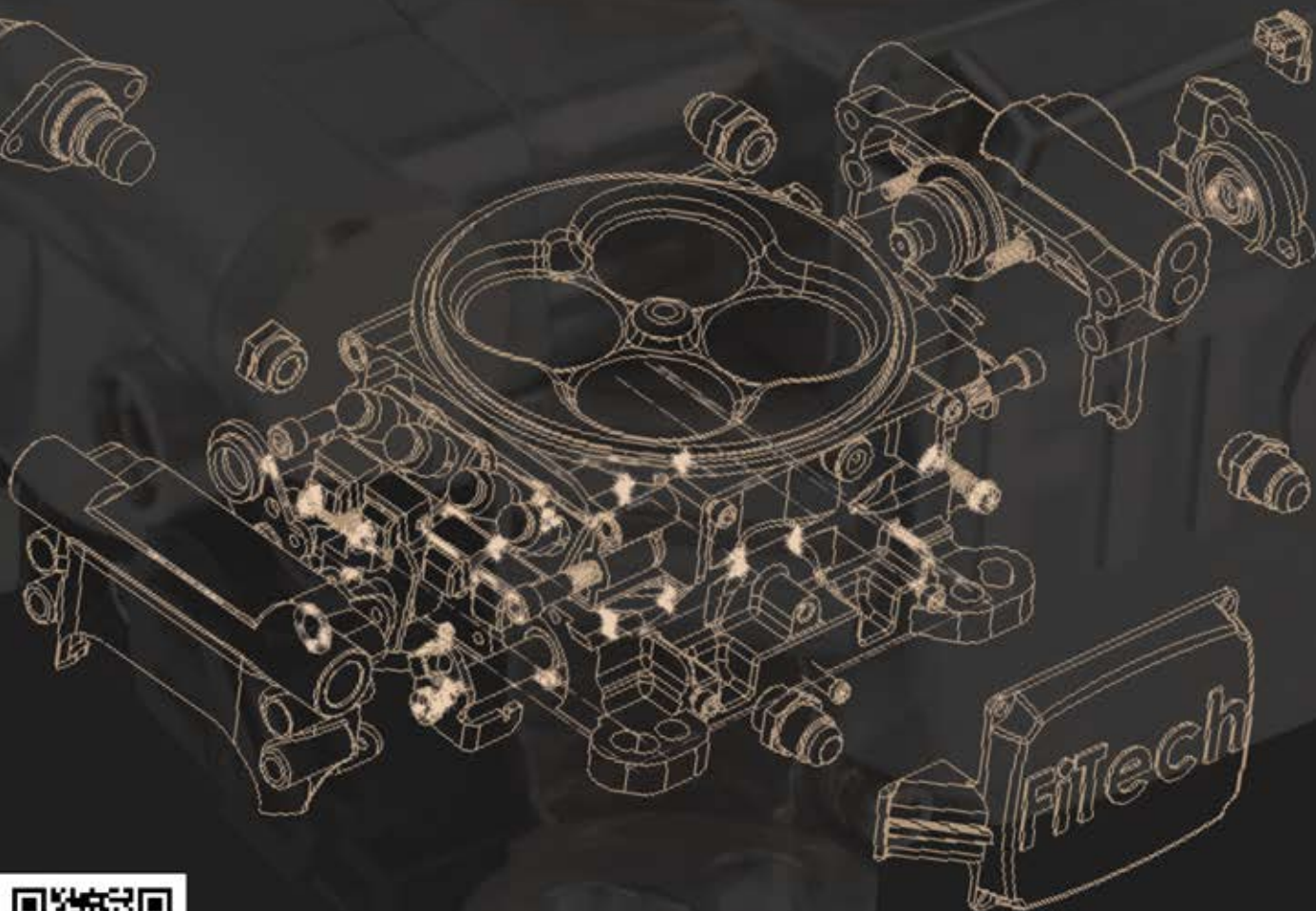

FITECHEFI.COM

CATALOG V4.0

Welcome to FiTech Fuel Injection

FiTech was launched with the goal of producing high quality electronic fuel injection technology to hot rod enthusiasts but in an affordable and easy-to-install system. Our first Go EFI Throttle Body systems delivered outstanding value and performance with OEM level functionality and improved driveability. Today we offer a number of different fuel injection systems ranging from 2-barrel upgrades to dual quad systems prepped for boost and nitrous to support 1,200 horsepower! Not only has our line of EFI components expanded, but we have also developed the Go-Shift Transmission Controller and a number of fuel delivery solutions in the form of our Force Fuel and Go Fuel product lines.

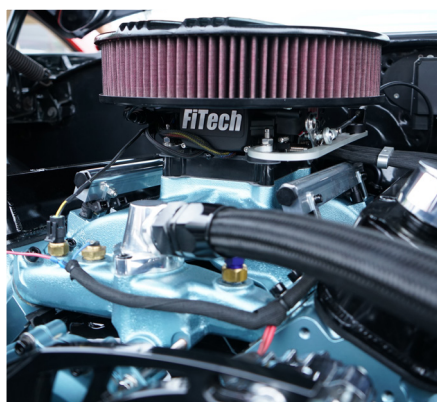

All of our new products are engineered to deliver performance and value while being easy to install and use. Every new system is designed and developed in Riverside, California using OEM level engineering resources, and components. Our software includes OBDII diagnostic readouts and limp home modes, just like factory ECU's. All of our EFI systems use advanced self-learning technology to constantly adjust to meet the demands of your engine regardless of climate or altitude. To keep things as easy as possible, everything can be programmed with the supplied touch screen monitor – no laptops are required!



FiTech
Fuel Injection



USA 951-340-2624
CANADA 877-521-7787



sales@fitechefi.com



www.fitechefi.com

Contents & Contacts

Overview, TBI EFI and Master Kits	4-5
Throttle Body Kits	6-12
Ultra Ram, TPI and Port EFI Kits	13-15
LS EFI Systems, Coils and Air Cleaners	16-20
Transmission Controls	21
Force Fuel Systems	22-23
Pump Modules and Tanks	24-25
Fuel Accessories	26-28
Capacitive Discharge Ignition (CDI)	29
Resources and Tech Support	30-31

CUSTOMER SUPPORT

We want to provide the best service possible. If you have any questions or comments, feel free to e-mail or call using any of the information below.

FiTech Fuel Injection

12370 Doherty St. Suite A
Riverside, CA 92503
Phone – 951-340-2624

www.fitechefi.com

Sales Email – sales@fitechefi.com

Tech Email – techmail@fitechefi.com

For help with orders please send email to: orders@fitechefi.com

Follow us!



@FiTechEFIMedia



@FiTech_EFI



@FITECHEFI



USA 951-340-2624
CANADA 877-521-7787



sales@fitechefi.com



www.fitechefi.com

FiTech
Fuel Injection

THROTTLE BODY EFI Systems

With FiTech TBI EFI systems, not only do you get the very latest in EFI technology, but you get the most affordable full featured systems available. You can pay more, but you won't get anything better than FiTech. We offer several different systems to fit the needs and budgets of hot rod enthusiasts. Below are just some of the features you'll see with our different Throttle Body EFI systems.



- **The fastest, most accurate self-learning technology available**
- **Wet flow annular discharge for superior fuel atomization**
- **Both 4-injector and 8-injector systems offered**
- **Power Adder versions support supercharging, turbocharging or nitrous**
- **Multi-bolt pattern mounts to most intakes**
- **Reliable Wide-Band Oxygen sensor**
- **Polished stainless steel linkage**
- **Fan control (up to two fans on Power Adder units)**

FiTech EFI At A Glance						
FEATURES	Go-Street EFI	Easy Street EFI	Mean Street EFI	Go EFI 4	Go EFI 4 PA	Go EFI 8 PA
Horsepower	100-400HP	200-600HP	200-800HP	200-600HP	200-600HP	250-1200HP
Injectors	4-56 lbs.	4-80 lbs.	8-62 lbs.	4-80 lbs.	4-80 lbs	8-80 lbs.
Self Learning	Yes	Yes	Yes	Yes	Yes	Yes
Integrated ECU	Yes	Yes	Yes	Yes	Yes	Yes
Timing Control	No	No	No	Yes	Yes	Yes
Fan Control	1 Fan	1 Fan	1 Fan	1 Fan	2 Fans	2 Fans
Boost Compatible	No	No	No	No	27 PSI	27 PSI
Nitrous Control	No	No	AFR Correction	No	Full Control	Full Control
Hand-held Tuner	Color Touch Screen	Color Touch Screen	Color Touch Screen	Color Touch Screen	Color Touch Screen	Color Touch Screen
Laptop Tuning	No	No	No	No	Yes	Yes

MANY MORE FEATURES AND SYSTEMS AVAILABLE!

4

WARNING: Cancer or Reproductive Harm
www.P65warnings.ca.gov

Emission Controlled Vehicle Information: Not legal for use on Emissions Controlled Vehicles. Check with your local DMV, emissions testing facility or applicable State laws before installing.

FiTech
Fuel Injection



USA 951-340-2624
CANADA 877-521-7787



sales@fitechefi.com



www.fitechefi.com

MASTER KITS

To make your EFI swap as easy as possible, you can order your EFI Kit with several different fuel delivery solutions. That means one part number gets you everything you need to convert your carbureted vehicle to EFI! We offer an Inline Pump Kit, three different Force Fuel Systems, In-Tank Pump Modules as well as a number of new tanks designed for fuel injection. Go to www.FiTechEFI.com for a full listing of our Master Kits.



Inline Pump Kit
Everything you need to install a high pressure pump on the frame rail, including '40 feet of hose, two filters, fittings and clamps. See page 27.



Force Fuel Systems
We offer multiple Force Fuel kits that allow you to keep the stock pump to feed the Force Fuel reservoir while its internal pump provides high pressure to the EFI system. See page 22-23.



In-Tank Modules
These universal kits allow you to modify your stock tank or fuel cell to accept a high pressure fuel pump. A feed line, vent and return are machined into the module for easy high pressure line connections. See page 24.



Complete Tanks
We now offer bolt-in tanks for many popular muscle cars and classic trucks including Camaros, Mustangs, Chevelles and more. The Tanks are baffled and designed to accept a high pressure pump for a great fit and finish. See page 25.

E85

FiTech EFI systems are compatible with E85, Ethanol, Methanol and Alcohol based fluids. It is important to note that E85 requires 30% more fuel to equal the same power level so you need to confirm that your EFI system is capable of flowing the extra E85 to reach your horsepower goals. (For example: 1,000HP Gas x 70% = 700HP E85)

 **WARNING:** Cancer or Reproductive Harm
www.P65warnings.ca.gov

Emission Controlled Vehicle Information: *Not legal for use on Emissions Controlled Vehicles. Check with your local DMV, emissions testing facility or applicable State laws before installing.*



USA 951-340-2624
CANADA 877-521-7787



sales@fitechefi.com



www.fitechefi.com

FiTech
Fuel Injection

GO STREET EFI 400HP System

The Go Street EFI is a ready-to-run system that sticks to the basic functions necessary to get the best performance and economy out of your street and mild performance engine. This throttle body system is economically priced and delivers the benefits of quick starts, smooth idle and self-learning technology to get you from sea level to over the mountains without a hitch. The system easily installs with most ignition systems and fits most intake patterns to replace your old carb.



Go Street, 400HP, PN 30003

Supplied with: Handheld controller, cable and windshield mount, throttle body vehicle side harness, WBO2 sensor, bung kit, coolant sensor, gasket, mini USB cable, instructions and warranty info.

STREET
SERIES

System	Horsepower	Integrated ECU	Timing Control	Boost Compatible	Nitrous Compatible	Laptop Software	Injectors	Built-in Regulator	MAP Sensor	Fan Control	AC Input	E85
30003	100-400	Yes	No	No	No	No	4	Yes	1-Bar	1	Yes	Yes
30005	200-600	Yes	No	No	No	No	4	Yes	1-Bar	1	Yes	Yes

EASY STREET 600HP System

With a classic gold finish, this Go Street system may have the looks of a factory carb, but the similarities end there. The pre-programmed assembly bolts right in place on a square-bore intake manifold and requires only a minimum of inputs to fire up. The Easy Street accepts the tach signal from the coil negative, an HEI distributor or from a CD ignition box for simple installation. A fast reacting wide-band O2 sensor is supplied to monitor the fuel burn signaling the self-learning technology of the ECU on adjustments to the mixture resulting in smooth performance from idle to high rpm.



Go Street, 600HP, PN 30005

Supplied with: Handheld controller, cable and windshield mount, throttle body vehicle side harness, WBO2 sensor, bung kit, coolant sensor, gasket, mini USB cable, instructions and warranty info.

MASTER KITS

Looking for an inclusive EFI Kit and fuel delivery solution? Check out www.fitechefi.com for a Master Kit that includes the EFI system along with an Inline Fuel Pump Kit, Force Fuel Kit, Tank Module or even a new Tank with an Internal Pump!

6



WARNING: Cancer or Reproductive Harm
www.P65warnings.ca.gov

Emission Controlled Vehicle Information: Not legal for use on Emissions Controlled Vehicles. Check with your local DMV, emissions testing facility or applicable State laws before installing.

FiTech
Fuel Injection



USA 951-340-2624
CANADA 877-521-7787



sales@fitechefi.com



www.fitechefi.com

MEANSTREET 800HP System



STREET
SERIES



Find more EFI Systems here!

Never has so much power been placed in one compact package! The Meanstreet is a nitrous compatible system with eight injectors, an onboard ECU, MAP sensor and internal fuel pressure regulator to deliver a simple, clean installation.

The Meanstreet's annular swirl, wet flow technology provides the most complete fuel atomization available. Using FiTech's proprietary self-tuning technology, combined with easy tuning of steps with the supplied handheld monitor, you'll have your high powered engine tuned and ready for the street or track. The matte black throttle body bolts to any 4-barrell intake and wiring is kept at an absolute minimum thanks to the built-in ECU.

Meanstreet EFI, 800HP, PN 30008

Note: Nitrous cannot be controlled by this system. When the nitrous is activated, the Meanstreet switches to a customer programmed AFR target.

Supplied with: Handheld controller, cable and windshield mount, throttle body vehicle side harness, WBO2 sensor, bung kit, coolant sensor, gasket, mini USB cable, instructions and warranty info.



The supplied color touchscreen is easy to view and navigate through many calibrations and settings.

MASTER KITS

Looking for an inclusive EFI Kit and fuel delivery solution? Check out www.fitechefi.com for a Master Kit that includes the EFI system along with an Inline Fuel Pump Kit, Force Fuel Kit, Tank Module or even a new Tank with an Internal Pump!

System	Horsepower	Integrated ECU	Timing Control	Boost Compatible	Nitrous Compatible	Laptop Software	Injectors	Built-in Regulator	MAP Sensor	Fan Control	AC Input	E85
30008	200-800	Yes	No	No	Yes (afr target)	No	8	Yes	1-Bar	1	Yes	Yes

WARNING: Cancer or Reproductive Harm
www.P65warnings.ca.gov

Emission Controlled Vehicle Information: Not legal for use on Emissions Controlled Vehicles. Check with your local DMV, emissions testing facility or applicable State laws before installing.

7



USA 951-340-2624
CANADA 877-521-7787



sales@fitechefi.com



www.fitechefi.com

FiTech
Fuel Injection

GO EFI 4 600HP System



GO EFI
SERIES

PN 30001



Find more EFI Systems here!



PN 30002

MASTER KITS

Looking for an inclusive EFI Kit and fuel delivery solution? Check out www.fitechefi.com for a Master Kit that includes the EFI system along with an Inline Fuel Pump Kit, Force Fuel Kit, Tank Module or even a new Tank with an Internal Pump!



PN 35201

The Go EFI 4 self-tuning fuel injection system is ideal for everyday drivers to weekend cruisers or even bracket cars making up to 600hp. The throttle body, available in bright aluminum or matte black, easily fits any 4-bbl intake manifold. Thanks to the built-in ECU, MAP sensor and fuel pressure regulator, wiring is kept to just a few connections for an easy install.

The quick self-learning technology that FiTech is known for, combined with our wet annular discharge design will you your engine fired up and idling smooth in minutes. All it takes are a few taps of the supplied touchscreen controller which can be left plugged in to use as gauges, or removed and stored in the glovebox.

Go EFI 4, 600HP, Bright Aluminum, PN 30001

Go EFI 4, 600HP, Matte Black, PN 30002

Supplied with: Handheld controller, cable and windshield mount, throttle body vehicle side harness, WBO2 sensor, bung kit, coolant sensor, gasket, mini USB cable, instructions and warranty info.

System	Horsepower	Integrated ECU	Timing Control	Boost Compatible	Nitrous Compatible	Laptop Software	Injectors	Built-in Regulator	MAP Sensor	Fan Control	AC Input	E85
30001/2	200-600	Yes	Yes	No	No	No	4	Yes	1-Bar	1	No	Yes

8



WARNING: Cancer or Reproductive Harm
www.P65warnings.ca.gov

Emission Controlled Vehicle Information: *Not legal for use on Emissions Controlled Vehicles. Check with your local DMV, emissions testing facility or applicable State laws before installing.*

FiTech
Fuel Injection



USA 951-340-2624
CANADA 877-521-7787



sales@fitechefi.com



www.fitechefi.com

GO EFI 4 600HP Power Adder

The Go EFI 4 Power Adder 600hp kit is just the ticket to replace a blow-through carb or looks right at home atop a roots style blower! This system is capable of supporting up to 21.7lbs of boost right out of the box as well as a single stage of wet nitrous.

The air/fuel ratio is monitored and adjusted with FiTech's fast reacting self-learning technology, plus the ignition timing can be controlled based on boost or nitrous (including a retard feature). Most of the settings can be controlled through the touch-screen handheld monitor, but this system also comes with Pro-Tuning software to run on a laptop for even more specific mapping and tuning.



NEW!

PN 30006

Go EFI 4 Power Adder, Black, 600HP, PN 30004

Go EFI 4 Power Adder, Bright Aluminum, 600HP, PN 30006

Supplied with: Handheld controller, cable and windshield mount, throttle body vehicle side harness, WBO2 sensor, bung kit, coolant sensor, gasket, mini USB cable, Pro-tuning laptop software, instructions and warranty info.

System	Horsepower	Integrated ECU	Timing Control	Boost Compatible	Nitrous Compatible	Laptop Software	Injectors	Built-in Regulator	MAP Sensor	Fan Control	AC Input	E85
30004/6	200-600	Yes	Yes	Yes	Yes	Yes	4	Yes	2.5-Bar	2	Yes	Yes
30012	250-1200	Yes	Yes	Yes	Yes	Yes	8	Yes	2.5 Bar	2	Yes	Yes

GO EFI 8 1200HP Power Adder



If things are getting really serious under your hood in regard to four digit horsepower with boost or nitrous, the Go EFI 8 1200hp Power Adder system is up to the task! This bolt-on throttle body features eight high-flow injectors capable of fueling up to 1200hp!

This system is made to support serious horsepower and is supplied with our pro-tuning software and features the ability to data-log information! To ensure the best atomization of the fuel injection, the annular discharge design is increased to 20 jet streams to support the fuel volume required under boost. This system features a built-in 2.5 BAR MAP sensor to handle the increased boost pressures and also has built-in timing controls based on boost or a nitrous input.

MASTER KITS

Looking for an inclusive EFI Kit and fuel delivery solution? Check out www.fitechefi.com for a Master Kit that includes the EFI system along with an Inline Fuel Pump Kit, Force Fuel Kit, Tank Module or even a new Tank with an Internal Pump!

Go EFI 8 Power Adder, 1200HP, PN 30012

Supplied with: Handheld controller, cable and windshield mount, throttle body vehicle side harness, WBO2 sensor, bung kit, coolant sensor, gasket, mini USB cable, Pro-tuning laptop software, instructions and warranty info.

WARNING: Cancer or Reproductive Harm
www.P65warnings.ca.gov

Emission Controlled Vehicle Information: Not legal for use on Emissions Controlled Vehicles. Check with your local DMV, emissions testing facility or applicable State laws before installing.

9



USA 951-340-2624
CANADA 877-521-7787



sales@fitechefi.com



www.fitechefi.com

FiTech
Fuel Injection

GO EFI CLASSIC

GO EFI
SERIES



If you prefer the restored or classic hot rod look, the Go EFI Classic is for you. You get the performance benefits of modern fuel injection, with the looks of a vintage carburetor (without the flooding, vapor lock and cold start issues).

The Go EFI Classic features our advanced self-tuning fuel metering technology and will support engines rated up to 650hp. Thanks to the dual bolt pattern, the throttle body will easily bolt onto most intake manifolds and throttle linkages. The ECU of the Classic series is compact and easy to mount out of sight to maintain a restored engine compartment but you'll notice the fuel injection benefits every time you turn the key!

Go EFI Classic, Gold, 650HP, PN 30020
Go EFI Classic, Black, 650HP, PN 30021

Supplied with: Remote ECU, handheld controller, cable and windshield mount, wiring harness, WBO2 sensor, bung kit, coolant sensor, gasket, mini USB cable, instructions and warranty info.

Note: A fuel pressure regulator is required unless using a regulated fuel delivery system. See pages 22-26 for fuel delivery options.

System	Horsepower	Integrated ECU	Timing Control	Boost Compatible	Nitrous Compatible	Laptop Software	Injectors	Built-in Regulator	MAP Sensor	Fan Control	AC Input	E85
30020	200-650	No	No	No	No	No	4	No	1-Bar	1	Yes	Yes
30021	200-550	No	No	No	No	No	4	No	1-Bar	1	Yes	Yes

MASTER KITS

Looking for an inclusive EFI Kit and fuel delivery solution? Check out www.fitechefi.com for a Master Kit that includes the EFI system along with an Inline Fuel Pump Kit, Force Fuel Kit, Tank Module or even a new Tank with an Internal Pump!

10



WARNING: Cancer or Reproductive Harm
www.P65warnings.ca.gov

Emission Controlled Vehicle Information: Not legal for use on Emissions Controlled Vehicles. Check with your local DMV, emissions testing facility or applicable State laws before installing.

FiTech
Fuel Injection



USA 951-340-2624
CANADA 877-521-7787



sales@fitechefi.com



www.fitechefi.com

GO EFI 2 BARREL 400HP



There are a lot of enthusiasts out there looking to update their 2-barrel fed cruisers with the driveability benefits of electronic fuel injection. The Go EFI 2 Barrel EFI system bolts to common H-2300 and R2G manifolds (with a TD-P#2086 adapter). The ECU is incorporated into the throttle body producing a simple installation with only a few wires to connect (fuel pump, ignition, power, and tach).

Go EFI 2 Barrel, 400HP System, PN 39001

Supplied with: Handheld controller, cable and windshield mount, throttle body vehicle side harness, WBO2 sensor, bung kit, coolant sensor, gasket, mini USB cable, instructions and warranty info.

System	Horsepower	Integrated ECU	Timing Control	Boost Compatible	Nitrous Compatible	Laptop Software	Injectors	Built-in Regulator	MAP Sensor	Fan Control	AC Input	E85
39001	100-400	Yes	Yes	No	No	No	4	Yes	1-Bar	1	No	Yes
39610	200-600	No	Yes	No	No	No	6	No	1-Bar	1	Yes	Yes

GO EFI 3x2 600HP System

The Go EFI is supplied with three 500 CFM throttle bodies and our self-learning EFI technology to deliver the looks you want with the performance and driveability benefits that only fuel injection can deliver! The Go EFI 3x2 system will support up to 600 horsepower and is designed to be a simple, ready-to-run installation. The compact ECU is easy to mount and only needs a few engine parameters to get your hot rod engine fired up.

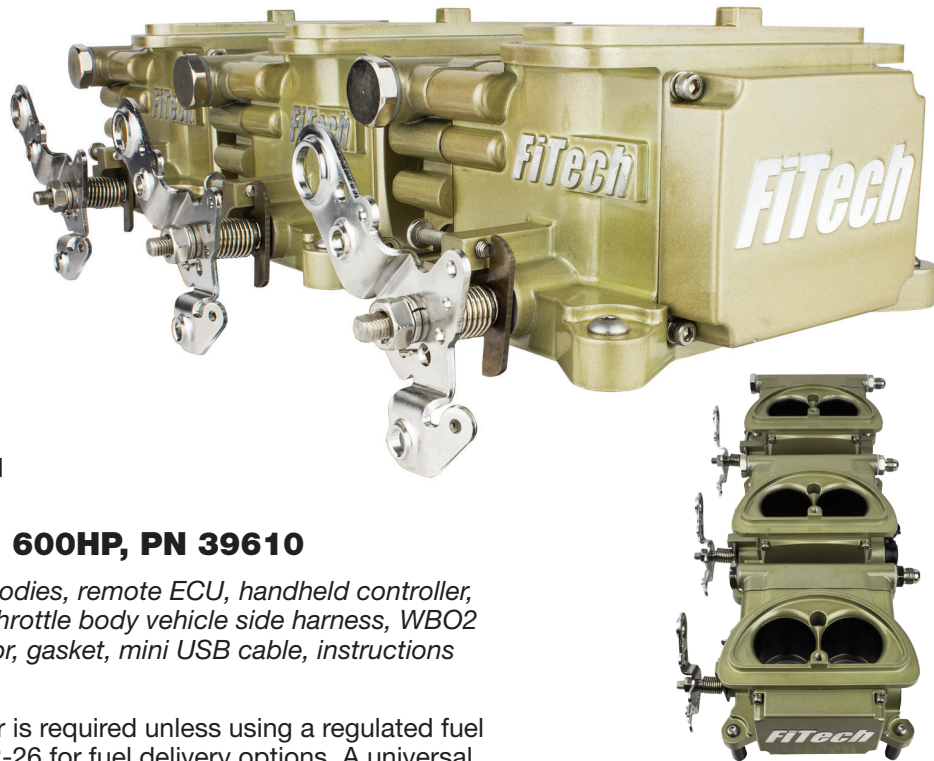

Go EFI Tri-Power 3x2, 600HP, PN 39610

Supplied with: Three throttle bodies, remote ECU, handheld controller, cable and windshield mount, throttle body vehicle side harness, WBO2 sensor, bung kit, coolant sensor, gasket, mini USB cable, instructions and warranty info.

Note: A fuel pressure regulator is required unless using a regulated fuel delivery system. See pages 22-26 for fuel delivery options. A universal linkage kit is available, PN 39611.

WARNING: Cancer or Reproductive Harm
www.P65warnings.ca.gov

Emission Controlled Vehicle Information: Not legal for use on Emissions Controlled Vehicles. Check with your local DMV, emissions testing facility or applicable State laws before installing.

11



USA 951-340-2624
CANADA 877-521-7787



sales@fitechefi.com



www.fitechefi.com

FiTech
Fuel Injection

GO EFI 2x4 625HP System

Let everyone know you mean business with a pair of 4-barrels crowned atop your engine! The 2x4 is supplied with two throttle bodies, one with the brains and integral ECU, the other with the brawn. Both bodies feature four injectors and will support up to 625 horsepower (naturally aspirated). Thanks to a multi-bolt pattern, the 2x4 system will bolt onto most intakes including tunnel rams or cross rams. Through the advanced tuning capabilities of the efficient ECU, you'll have your engine fired up, idling smooth and making big power in no time!



Go EFI 2x4 625HP System
Bright Aluminum, PN 30061
Matte Black, PN 30062

Supplied with: Two throttle bodies, handheld controller, cable and windshield mount, throttle body vehicle side harness, WBO2 sensor, bung kit, coolant sensor, gasket, mini USB cable, instructions and warranty info.



PN 30062

Note: Intake and throttle linkage not supplied.

System	Horsepower	Integrated ECU	Timing Control	Boost Compatible	Nitrous Compatible	Laptop Software	Injectors	Built-in Regulator	MAP Sensor	Fan Control	AC Input	E85
30061/2	200-625	Yes	Yes	No	No	No	8	Yes	1-Bar	1	No	Yes
30064/5	400-1200	Yes	Yes	Yes	Yes	Yes	8	Yes	2.5-Bar	2	Yes	Yes

GO EFI 2x4 1200HP Power Adder

Make a statement with a pair of throttle bodies feeding your 671 or 871 roots blower with this 2x4 Power Adder system. This kit will also support up to 1200hp on a naturally aspirated engine. Once fired up, the self-learning technology will get the engine idling and cruising well, but more detailed programming can be made through the advanced pro-tuning software including fuel and timing maps under boost or nitrous. One throttle body houses the ECU while the other secures the Idle Air Control solenoid and four more injectors.



Go EFI 2x4 1200HP Power Adder System,
Matte Black, PN 30064
Bright Aluminum, PN 30065 *NEW!*

Supplied with: Two throttle bodies, handheld controller, cable and windshield mount, throttle body vehicle side harness, WBO2 sensor, bung kit, coolant sensor, gasket, mini USB cable, Pro-tuning laptop software, instructions and warranty info.



PN 30065

MASTER KITS

Looking for an inclusive EFI Kit and fuel delivery solution? Check out www.fitechefi.com for a Master Kit that includes the EFI system along with an Inline Fuel Pump Kit, Force Fuel Kit, Tank Module or even a new Tank with an Internal Pump!

12 **WARNING:** Cancer or Reproductive Harm
www.P65warnings.ca.gov

Emission Controlled Vehicle Information: Not legal for use on Emissions Controlled Vehicles.
 Check with your local DMV, emissions testing facility or applicable State laws before installing.

FiTech
 Fuel Injection



USA 951-340-2624
 CANADA 877-521-7787



sales@fitechefi.com



www.fitechefi.com

ULTRA RAM KITS



PN 38301

**Now Available for
Big Block Chevys!**



Our Ultra Ram EFI Systems deliver outstanding port fuel injection performance with an aggressive looking sheet metal intake manifold. The design of the Ultra Ram intake performs as good as it looks and will support up to 600 horsepower (naturally aspirated).

The system comes ready to go out of the box with the injectors and fuel rails installed. The robust ECU is easy to mount and handles the air/fuel mixture targets with self-learning technology so no laptop is required. In fact, you only need to input a few engine specs into the color touch screen monitor to get the engine to fire up. The Ultra Ram is ideal for crate motors or your custom built engine and will deliver great performance with the looks to match.

Ultra Ram, Small Block Chevy, PN 38301

Ultra Ram, Big Block Chevy, Rectangle Port, PN 38302 *NEW!*



Supplied with: Sheet metal intake, cast aluminum throttle body, remote mount ECU, main harness, handheld controller, cable and windshield mount, WBO2 sensor, bung kit, coolant sensor, gasket, mini USB cable, instructions and warranty info.

Note: A fuel pressure regulator is required unless using a regulated fuel delivery system.
See pages 22-26 for fuel delivery options.

MASTER KITS

Looking for an inclusive EFI Kit and fuel delivery solution? Check out www.fitechefi.com for a Master Kit that includes the EFI system along with an Inline Fuel Pump Kit, Force Fuel Kit, Tank Module or even a new Tank with an Internal Pump!

System	Horsepower	Integrated ECU	Timing Control	Boost Compatible	Nitrous Compatible	Laptop Software	Injectors	Built-in Regulator	MAP Sensor	Fan Control	AC Input	E85
38301	200-600	No	Yes	Yes	No	Yes	8	No	3-Bar	1	Yes	Yes
38302	200-800	No	Yes	Yes	No	Yes	8	No	3-Bar	1	Yes	Yes

WARNING: Cancer or Reproductive Harm
www.P65warnings.ca.gov

Emission Controlled Vehicle Information: *Not legal for use on Emissions Controlled Vehicles. Check with your local DMV, emissions testing facility or applicable State laws before installing.*

13



USA 951-340-2624
CANADA 877-521-7787



sales@fitechefi.com



www.fitechefi.com

FiTech
Fuel Injection

GO PORT EFI 500HP & 1050HP



PN 37858

GO PORT

The Go Port EFI system features eight injectors placed precisely in each intake runner to inject fuel right into the cylinder head port. A sequential batch port fuel design provides excellent throttle response, effective fuel atomization and delivery resulting in terrific throttle response and overall performance.

FiTech offers two complete systems; a kit for up to 550 horsepower and a 1050 horsepower kit. Each system is supplied with a new aluminum intake machined and fitted with injectors (36 or 80 lbs), fuel rails, the wiring harness and an 850 cfm throttle body. The ECU, with its high speed processor, is integral to the throttle body along with the TPS, IAC, IAT and MAP sensors reducing wiring and making installation as easy as possible. All setup is handled through the color touchscreen monitor with no tuning experience necessary to have your engine fired up and running at its best.

Small Block Chevy
200-550 HP, PN 37854
550-1050 HP, PN 37858

Big Block Chevy
Oval Port, 200-550 HP, PN 30454
Oval Port, 550-1050 HP, PN 30458
Rectangle Port, 200-550 HP, PN 30254
Rectangle Port, 550-1050 HP, PN 30258

Go Port Stand Alone System, PN 30014

Using your own intake? This system is supplied with everything you need to adapt EFI to your intake and fuel rails.

Supplied with: Throttle body, aluminum intake manifold, fuel rails, injectors, handheld controller, cable and windshield mount, wiring harness, WBO2 sensor, bung kit, coolant sensor, gasket, mini USB cable, Pro-tuning laptop software, instructions and warranty info.

System	Horsepower	Integrated ECU	Timing Control	Boost Compatible	Nitrous Compatible	Laptop Software	Injectors	Built-in Regulator	MAP Sensor	Fan Control	AC Input	E85
SBC	200-550	No	Yes	Yes	Yes	Yes	8	No	2.5-Bar	2	Yes	Yes
BBC	550-1050	No	Yes	Yes	Yes	Yes	8	No	2.5-Bar	2	Yes	Yes

14



WARNING: Cancer or Reproductive Harm
www.P65warnings.ca.gov

Emission Controlled Vehicle Information: *Not legal for use on Emissions Controlled Vehicles. Check with your local DMV, emissions testing facility or applicable State laws before installing.*

FiTech
 Fuel Injection



USA 951-340-2624
 CANADA 877-521-7787



sales@fitechefi.com



www.fitechefi.com

RETRO-FIT GM TPI



NEW!



There are thousands of small-block Chevy engines that were fueled by their Tuned Port Injection (TPI) systems back the mid '80s to early '90s. These were popular engine swaps years ago, but the electronics and tuning left a lot to be desired. To help bring your GM TPI system up to date, we now offer a Retro-Fit kit these engines that provides improved calibration and tuning along with our proven self-learning EFI technology.

The robust ECU is easy to mount and connects through a complete wiring harnesses that is terminated with factory style connectors to ease installation. The harness plugs into the factory distributor, injectors and sensors then can easily be calibrated to your specifications through the color touchscreen handheld controller.

Retro-Fit GM TPI System, PN 38350

Supplied with: ECU, handheld controller, cable and windshield mount, TPI wiring harness, WBO2 sensor, mini USB cable, instructions and warranty info.

Note: Works with OEM CTS, IAC, TPS and Knock Sensors.

- Upgrade old GM TPI systems to modern technology
- Improved driveability and performance
No laptop required – easy to use touchscreen controller supplied
- New wiring harness connects to factory sensors and components
- Proven self-learning technology and performance
- Lock-up control for 200-4R/700-R4 trans
- Upgraded kits available for use with 4L60/80E transmissions

System	Horsepower	Integrated ECU	Timing Control	Boost Compatible	Nitrous Compatible	Laptop Software	Injectors	Built-in Regulator	MAP Sensor	Fan Control	AC Input	E85
38350	200-600	No	No	No	No	No	8	No	No	1	Yes	Yes

WARNING: Cancer or Reproductive Harm
www.P65warnings.ca.gov

Emission Controlled Vehicle Information: Not legal for use on Emissions Controlled Vehicles. Check with your local DMV, emissions testing facility or applicable State laws before installing.

15



USA 951-340-2624
CANADA 877-521-7787



sales@fitechefi.com



www.fitechefi.com

FiTech
Fuel Injection

ULTIMATE LS EFI SYSTEMS

We have made it easy to help finish your LS swap with our Ultimate LS Induction Systems. These systems are based on a short and long runner sheet metal intake manifold that comes complete with injectors, fuel rails, a cast throttle body and everything you need to install the system. Different systems are available to support 500-1,000 HP and to fit different head combinations. Complete kits are available with fuel systems and performance coils!



E85

- Cast, cable activated throttle body with a 92mm or 102mm inlet
- Self-learning technology maintains your target air/fuel ratio settings
- Sequential fuel and spark control with individual cylinder trim
- Connects to 24x and 58x cam sensors
- Knock sensor control connects to factory sensors
- 3-Bar MAP sensor for boosted applications up to 30-psi
- Tach output driver works with most tachs
- Two programmable electric fan outputs
- Supplied with WBO2 Sensors (one with 500HP Kit)
- Custom wiring harness for a direct plug-in installation
- Systems with trans control allows shift point and firmness adjustments on 4L60/65/80/85E transmissions

16 **WARNING:** Cancer or Reproductive Harm
www.P65warnings.ca.gov

Emission Controlled Vehicle Information: Not legal for use on Emissions Controlled Vehicles. Check with your local DMV, emissions testing facility or applicable State laws before installing.

FiTech
Fuel Injection

USA 951-340-2624
CANADA 877-521-7787

@
sales@fitechefi.com

www.fitechefi.com

LS ENGINE **EFI** Systems

The Ultimate LS Induction Systems are designed as a complete induction and EFI system for your LS engines with kits to support 500, 750 and 1,000 HP. We offer a number of Master Kits that are supplied with fuel delivery systems as well as our Go Spark LS3 Coils.

For a complete list of MASTER Kits, go to www.fitechefi.com

	Intake/EFI	Master Kit w/ Inline Pump Kit	Master Kit w/ Force Fuel Kit	w/ Intank Module, 340LPH Pump Regulator, LS3 Coils	w/Intank Module 440LPH Pump and Regulator
Ultimate LS Kits, 500HP without Trans Control					
LS1/LS2/LS6, Short Intake	70001*	71001*	75201	79601	76101
LS1/LS2/LS6, Tall Intake	70006*	71006*	75206	79606	76106
LS3/L92	70011*	71011*	75211	79611	76111
LS7 Square Port	70015*	71015*	75215		76115
Ultimate LS Kits, 500HP with Trans Control					
LS1/LS2/LS6, Short Intake	70002*	71002*	75202	79602	76102
LS1/LS2/LS6, Tall Intake	70007*	71007*	75207	79607	76107
LS3/L92, Short Intake	70012*	71012*	75212	79612	76112
LS7 Square Port	70016*	71016*	75216		76116
Ultimate LS Kits, 750HP without Trans Control					
LS1/LS2/LS6, Short Intake	70003*	71003*	75203	79603	76103
LS1/LS2/LS6, Tall Intake	70008*	71008*	75208	79608	76108
LS3/L92	70013*	71013*	75213	79613	76113
LS7 Square Port	70017*	71017*	75217		76117
Ultimate LS Kits, 750HP with Trans Control					
LS1/LS2/LS6, Short Intake	70004*	71004*	75204	79604	76104
LS1/LS2/LS6, Tall Intake	70009*	71009*	75209	79609	76114
LS3/L92	70014*	71014*	75214	79614	76118
LS7 Square Port	70018*	71018*	75218	76109	
Ultimate LS Kits, 1,000HP without Trans Control					
LS1/LS2/LS6, Short Intake	70030				76130
LS1/LS2/LS6, Tall Intake	70032				76132
LS3/L92	70034				76134
LS7 Square Port	70036				76136
Ultimate LS Kits, 1,000HP with Trans Control					
LS1/LS2/LS6, Short Intake	70031				76131
LS1/LS2/LS6, Tall Intake	70033				76133
LS3/L92	70035				76135
LS7 Square Port	70037				76137

*Regulator Required, see page 26.

LS Port ID

Raised Rectangle Port



**LS7
LSX_R**

Rectangle Port



**L76
L92
L99
LSX_R**

Cathedral Port



**LS1
LS2
LS6
LSX
LSX_{RT}**

Over the 20+ years that the Gen III small block has been available, GM has used a number of different intake port configurations. We offer LS EFI intake systems to cover most OEM applications including aftermarket heads. These drawings will help you determine your intake ports.

**Find
more LS
systems
here!**



WARNING: Cancer or Reproductive Harm
www.P65warnings.ca.gov

Emission Controlled Vehicle Information: Not legal for use on Emissions Controlled Vehicles. Check with your local DMV, emissions testing facility or applicable State laws before installing.



USA 951-340-2624
CANADA 877-521-7787



sales@fitechefi.com



www.fitechefi.com

FiTech

Fuel Injection

RETRO-LS TBI with Trans Control



There are many hot rodders out there that want the performance of an LS engine, but prefer the old school looks of a carburetor. FiTech's Retro LS TBI is plated in classic carburetor gold and bolts to an LS intake made for carburetors to deliver all the driveability benefits of a factory EFI system.

For ease of installation, a wiring harness is supplied that is already terminated with the specific LS engine sensors, including the factory knock sensors to complement the built-in timing control. On top of that, the ECU also has the ability to control the transmission shift points and characteristics of the popular 4L60/65/80E transmissions. No laptop is required and the system will work on 24x or 58x cam sensors.

Retro-LS Kit, Classic Gold, PN 37001

Supplied with: Throttle body, remote ECU, handheld controller, cable and windshield mount, LS wiring harness, WBO2 sensor, bung kit, gaskets, mini USB cable, instructions and warranty info.

System	Horsepower	Integrated ECU	Timing Control	Boost Compatible	Nitrous Compatible	Laptop Software	Injectors	Built-in Regulator	MAP Sensor	Fan Control	AC Input	E85
37001	250-650	No	Yes	Yes	No	No	4	No	3-Bar	2	Yes	Yes
70081/82	250-750	No	Yes	Yes	No	Yes	8	No	3-Bar	2	Yes	Yes

RETRO-LS 2x4



Looking for something different and cool for your LS engine? The new dual quad throttle body system will really stand out in a sea of LS engines thanks to our unique sheet metal intake manifold topped with two throttle bodies!

The trick intake is plumbed with fuel rails and eight injectors set up as a sequential EFI system. Thanks to our well proven self-learning technology, the 2x4 will idle smooth and cruise at low rpm, but is ready to go when you hit the pedal.

Retro-LS 2x4 EFI System Gold, PN 70081 Matte Black, PN 70082

Supplied with: Sheet metal intake, fuel rails, injectors, throttle bodies, remote ECU, handheld controller, cable and windshield mount, LS wiring harness, WBO2 sensor, bung kit, MAP sensor, gaskets, mini USB cable, instructions and warranty info.

Note: A fuel pressure regulator is required unless using a regulated fuel deliver system. See pages 22-26 for fuel delivery options.

NEW!

18 **WARNING:** Cancer or Reproductive Harm
www.P65warnings.ca.gov

Emission Controlled Vehicle Information: Not legal for use on Emissions Controlled Vehicles. Check with your local DMV, emissions testing facility or applicable State laws before installing.

FiTech
Fuel Injection



USA 951-340-2624
CANADA 877-521-7787



sales@fitechefi.com



www.fitechefi.com

RETRO-LS 3x2



NEW!

If you're putting an LS engine in a muscle car, there's no better induction system than a tri-power setup. FiTech now offers an exclusive sheet metal intake to bolt onto an LS giving you the true muscle car appearance but with the modern driveability and performance that you crave.

The new 3x2 system features three 500 cfm throttle bodies that are finished in a classic gold to enhance the muscle car vibe. The self-learning technology provides quick starts, smooth idle and great throttle response without the overly rich fueling of old-school carbs. The harness plugs into the LS cam, crank, and coolant sensors and is simple to setup with the supplied touch screen monitor.

Retro-LS 2x3 EFI System, PN 70080

Supplied with: Sheet metal intake, fuel rails, injectors, throttle bodies, remote ECU, handheld controller, cable and windshield mount, LS wiring harness, WBO2 sensor, bung kit, MAP sensor, gaskets, mini USB cable, instructions and warranty info.

Note: A fuel pressure regulator is required unless using a regulated fuel delivery system. See pages 22-26 for fuel delivery options. A universal linkage kit is available, PN 39611.



System	Horsepower	Integrated ECU	Timing Control	Boost Compatible	Nitrous Compatible	Laptop Software	Injectors	Built-in Regulator	MAP Sensor	Fan Control	AC Input	E85
70080	250-750	No	Yes	Yes	No	Yes	8	No	3-Bar	2	Yes	Yes
70050/51	NA	No	Yes	Yes	No	Yes	8	No	3-Bar	2	Yes	Yes

STANDALONE LS EFI



If you've located a donor LS system or even a new crate engine with the factory intake, injectors and sensors, FiTech has an easy and affordable system to manage the fuel delivery and ignition with the Stand Alone EFI System.

A compact ECU is easy to mount and efficiently controls the air/fuel mixture feeding the engine. Our proven self-learning technology keeps the engine running exactly where you program it through the supplied touch screen controller. A complete wiring harness is supplied along with two WBO2 sensors for a complete installation to your new LS powerplant.

Supplied with: ECU, handheld controller, cable and windshield mount, LS wiring harnesses, MAP sensor, WBO2 sensors, bung kits, mini USB cable, instructions and warranty info.

Standalone LS EFI System without Trans Control, PN 70050 with Trans Control, PN 70051

WARNING: Cancer or Reproductive Harm
www.P65warnings.ca.gov

Emission Controlled Vehicle Information: Not legal for use on Emissions Controlled Vehicles. Check with your local DMV, emissions testing facility or applicable State laws before installing.

19



USA 951-340-2624
CANADA 877-521-7787



sales@fitechefi.com



www.fitechefi.com

FiTech
Fuel Injection

GO SPARK LS3 COILS



PN 79110

NEW!



PN 79210

Our new LS3 style coils will help complete your LS EFI swap or even update your modern muscle car with a fresh jolt of energy. The Go-Spark LS Coils were developed to deliver optimum output with a quality fit and reliability. The Coils bolt-in place of the originals and accept the sealed, locking connector and plug wire terminal for a simple upgrade.

If you're looking for a little more dazzle under your hood, we also offer a Coil with a built-in LED that flashes when the coil is firing!

Go Spark Coil, no LED
Single, PN 79110
8-Pack, PN 79100

Go Spark Coil, with LED
Single, PN 79210
8-Pack, PN 79200

HIGH FLOW AIR CLEANER

Cap off your LS or Ultra Ram throttle body with a new high flow cotton-based air cleaner. The open design of the conical filter allows the engine to pull air from both inside the cone as well as from the outside perimeter. That nearly doubles the element area to capture any contaminant particles so only the cleanest air makes it into your intake.

The 6-inch long cone shaped filter is capped on both ends with a show quality chrome housing securing the filter. A rubber coupler and heavy-duty clamp are supplied to seal over the flange creating a tight seal and secure mount with a 4" diameter at the front. The filter can be washed and reused for many miles and many years to come.

Conical Air Filter
92mm, PN 41000
102mm, PN 41001



NEW!



20



WARNING: Cancer or Reproductive Harm
www.P65warnings.ca.gov

Emission Controlled Vehicle Information: *Not legal for use on Emissions Controlled Vehicles. Check with your local DMV, emissions testing facility or applicable State laws before installing.*

FiTech
Fuel Injection



USA 951-340-2624
CANADA 877-521-7787



sales@fitechefi.com



www.fitechefi.com

GO-SHIFT Transmission Controller

The Go-Shift stand-alone electronic transmission control is the perfect solution when it comes to managing a GM or Ford electronic 4-speed transmission. Like our EFI systems, the Go-Shift is designed to be easy to install, affordable and simple to program.

In fact, all of the transmission settings, including shift points, firmness and converter lock-up can be adjusted through the supplied handheld monitor! A harness, complete with OEM style sealed connectors, makes installation a plug 'n play affair while the compact ECU easily mounts out of the way. After setting up the trans, you can disconnect the monitor or keep it plugged in to view transmission data.

Go-Shift Transmission Control
GM 4L60/65/80/85LE, PN 20010
Ford AODE, PN 20011
Ford 4R70W, PN 20012

NOW FOR FORDS!

Supplied with: ECU, transmission wiring harness, color touchscreen monitor, cable and dash mount.

- Easily adjust the rpm points and firmness of each shift
- Direct plug-in harness for ease of installation
- Speedometer calibration and output
- Compatible with paddle shift inputs
- Control the torque converter clutch lock-up



The Go-Shift Trans Controller is easy to setup up and tune through the supplied touchscreen controller. Setup and easily adjust the shift characteristics with the supplied touchscreen controller.

WARNING: Cancer or Reproductive Harm
www.P65warnings.ca.gov

Emission Controlled Vehicle Information: Not legal for use on Emissions Controlled Vehicles. Check with your local DMV, emissions testing facility or applicable State laws before installing.

21



USA 951-340-2624
 CANADA 877-521-7787



sales@fitechefi.com



www.fitechefi.com

FiTech
 Fuel Injection

GO FUEL Force Fuel Systems



The heavy duty bracket can be installed on the bottom or side of the tank to ease mounting.

The Force Fuel System mounts under the hood and is fed with the original mechanical or electric fuel pump then supplies the EFI system with the required high pressure through the use of an internal 340-LPH pump. This means you don't need to run a new feed line from the tank!

The assembly is easy to mount with a bottom or side bracket and to ensure clean fuel reaches the injectors, a serviceable 10-micron fuel filter is supplied. The reservoir holds half-a-gallon of fuel to submerge an internal electric fuel pump to keep it cool and no chance of fuel starvation. An internal regulator keeps the pressure at a consistent 58-psi, ideal for reliable EFI performance.

Force Fuel System, PN 50004

Supplied with 5-feet of high pressure fuel hose, 10-micron fuel filter, AN fittings, return line fitting bung and liquid filled gauge.

DETAILS

- Supports the fuel demands of an 800-hp engine on gas
- No fuel slosh - ideal for autocross and off-road
- Effective 10-micron serviceable filter ensures the best filtration
- Increased fuel capacity over other systems – no chance of cavitation, even under hard cornering or acceleration
- Capable of running with E-85, ethanol or methanol based fuels

22



WARNING: Cancer or Reproductive Harm
www.P65warnings.ca.gov

Emission Controlled Vehicle Information: Not legal for use on Emissions Controlled Vehicles. Check with your local DMV, emissions testing facility or applicable State laws before installing.

FiTech
Fuel Injection



USA 951-340-2624
CANADA 877-521-7787



sales@fitechefi.com



www.fitechefi.com

GO FUEL Force Fuel Systems

Mini Force - 600HP

The popularity of the Force Fuel System spurred the demand for a smaller version to fit cramped engine compartments.

The Mini Force is fed through a low-pressure mechanical (or electric) pump saving the need to modify the entire fuel system. The reservoir of the Mini is equipped with an efficient 255-LPH pump and internal regulator to deliver a consistent 58-psi of fuel pressure for your EFI system.

The compact design of the new Mini Force Fuel fits easily under the hoods of street rods and smaller engine compartments. To make installing the Mini easier, its mounting bracket is designed to be installed in four positions.

Mini Force Fuel, PN 50006

Supplied with high pressure fuel hose, AN fittings, return line fitting bung and liquid filled gauge



**New
Compact
Size!**

**8" Tall
5" Wide
4.5" Deep**

Dual Force - 1,600HP

The new FiTech Dual Pump Force Fuel System makes the upgrade to EFI easy while supporting serious horsepower – up to 1,600 horsepower (NA)!

The system works in concert with a mechanical or electric fuel pump to supply the Force Fuel reservoir with fuel where it is then fed through two internal 340-LPH pumps to feed the EFI system. Dual internal regulators keep the pressure at 58-psi which is ideal for reliable EFI performance.

With a strong, versatile mounting bracket, the Force Fuel System easily mounts under the hood. The assembly holds half-a-gallon of fuel to submerge the efficient pumps with no chance of fuel starvation.

Dual Force Fuel, PN 50005

**Supports
up to
1,600 (NA)!**



E85

**NEW Higher
Horsepower!**

**10" Tall
7" Wide
5" Deep**

WARNING: Cancer or Reproductive Harm
www.P65warnings.ca.gov

Emission Controlled Vehicle Information: Not legal for use on Emissions Controlled Vehicles.
Check with your local DMV, emissions testing facility or applicable State laws before installing.

23



USA 951-340-2624
CANADA 877-521-7787



sales@fitechefi.com



www.fitechefi.com

FiTech
Fuel Injection

GO FUEL Pump Modules

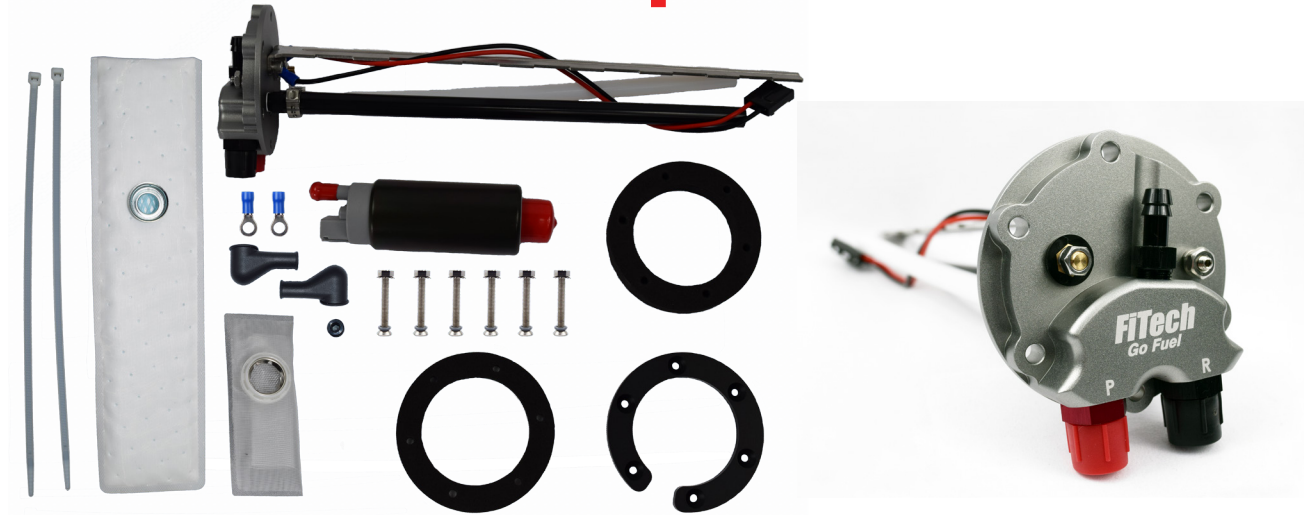

In-Tank Pump Module

Our universal Pump Module can be used on tanks with a depth of 6" to 15". The billet top assembly was designed with the supply and return ports in a parallel position to help route the fuel lines easily and evenly. The vent port is on the other side to ease routing the line near the fill tube. The two fuel ports are threaded to accept -6 AN O-ring boss fittings for a secure, leak-free connection. A 340 LPH pump is included along with gaskets, terminals and clamps.

In-Tank Pump Module
with 340LPH Pump, PN 50015
with 440LPH Pump, PN 50016 *NEW!*

Note: Will directly bolt into tanks offered by TANKS Inc.

Fuel Cell Pump Module

If you're running a fuel cell or custom tank, this Pump Module is the solution to your high pressure fuel needs. The billet top assembly is machined with a 2" filler assembly as well as an internal regulator to maintain 58-psi. This system is designed so no return line is needed! The Module is machined to fit fuel cells with a 12-bolt flange or can be installed on any tank with the supplied hardware. Two models are available, a single and dual pump.

Fuel Cell Pump Modules
Single Pump, PN 50019
Dual Pump, PN 50020 *NEW!*

Filler Extensions
2-inch, PN 50019-2
3-inch, barb, PN 50019-3
4-inch, PN 50019-4

Filler Cap, PN 50019-1



PN 50019

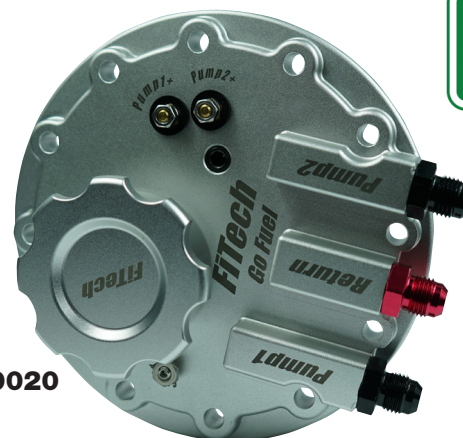

PN 50020

24



WARNING: Cancer or Reproductive Harm
www.P65warnings.ca.gov

Emission Controlled Vehicle Information: Not legal for use on Emissions Controlled Vehicles.
 Check with your local DMV, emissions testing facility or applicable State laws before installing.

FiTech
 Fuel Injection



USA 951-340-2624
 CANADA 877-521-7787



sales@fitechefi.com



www.fitechefi.com

EFI TANKS with Internal Pumps



FiTech now offers brand new tanks made to accept our In-Tank Pump Module! These new tanks are designed as direct bolt-ins to popular muscle cars and classics making the swap to EFI even easier!

Fuel Injection demands higher pressure from an electric fuel pump and the best place to mount a pump is in the gas tank. Our new In-Tank Module secures the supplied electric pump and bolts directly into the new tank providing a modern EFI solution!

For a full listing of EFI-ready tanks, go to www.FiTechEFI.com

Now available with a 440 LPH pump to support up to 1,000 horsepower (NA)!

- Direct-fit tanks feature internal baffles for constant fuel delivery
- In-Tank Pump Module secures the supplied electric pump in the tank
- -6 AN inlet/outlet provide leak-free fuel line connections
- Recessed sending unit mount provides added clearance
- New mounting straps and fuel level sending unit supplied



GM Tanks



Mopar Tanks



Ford Tanks

WARNING: Cancer or Reproductive Harm
www.P65warnings.ca.gov

Emission Controlled Vehicle Information: Not legal for use on Emissions Controlled Vehicles. Check with your local DMV, emissions testing facility or applicable State laws before installing.

25



USA 951-340-2624
CANADA 877-521-7787



sales@fitechefi.com



www.fitechefi.com

FiTech
Fuel Injection

GO FUEL Components



54001

54002

Regulators

The new Go Fuel Regulators allow you to set the fuel pressure precisely where your EFI system and engine require. Both models can be adjusted from 30 – 70 psi. Our Tight Fit regulators will support up to 1,000 horsepower while the High Horsepower model will support 2,000 HP. Crafted from billet aluminum, the regulators feature -6 ORB ports along a vacuum/boost port and will accept a gauge. Two models are available; a compact unit with a single output as well as a larger, dual output model.

- Tight Fit, No Gauge, PN 54000**
- Tight Fit, with Gauge, PN 54001**
- High Horsepower, with Gauge, PN 54002**

Fuel Filters

One of the most important aspects of a reliable fuel injection system is clean fuel. To help ensure that nothing but debris-free fuel reaches the injectors, we offer three high flow, serviceable filter assemblies.



Billet Fuel Filter, PN 55003

This 100-micron filter is designed to be placed between the fuel tank and the pump. This filter is a replacement for the one supplied with our Inline Pump Kit, 50001.

10-Micron Filter, PN 55002 100-Micron, PN 55003

These new serviceable fuel filters are designed to go between the fuel pump and the EFI system or carburetor. The billet assembly has -8 ORB ports and features a serviceable magnetic element that will trap debris down to 10- or 100-microns to ensure nothing but clean fuel makes it to the injectors.

Universal Check Valve, PN 55001

This universal check valve will keep the fuel from leaking back into the fuel tank when your car is parked. This keeps the system primed and ready for quick starts and consistent performance.

26



WARNING: Cancer or Reproductive Harm
www.P65warnings.ca.gov

Emission Controlled Vehicle Information: Not legal for use on Emissions Controlled Vehicles. Check with your local DMV, emissions testing facility or applicable State laws before installing.

FiTech
Fuel Injection



USA 951-340-2624
CANADA 877-521-7787



sales@fitechefi.com



www.fitechefi.com

ACCESSORIES

Inline Pump Kit, PN 50001

This kit is supplied with our heavy duty 255 LPH external fuel pump that is suitable to support engines producing up to 600 (NA) horsepower. The kit includes 40 feet of high pressure fuel hose, two fuel filters including a serviceable 10-micron filter, fittings, mounts and clamps.



Inline Fuel Pump, PN 50101

This fuel pump delivers performance and endurance. This is the same pump supplied with our 50001 Inline Fuel Pump Kit.



Fuel Pump Mounting Kit, PN 80110

This heavy duty billet fuel pump mounting bracket will fit both 52mm and 60mm diameter fuel pumps.



Fuel Pressure Gauges

15 psi, Standard, PN 80116

100 psi, Standard, PN 80115

15 psi, Liquid Filled, PN 80117

100 psi, Liquid Filled, PN 80118

These gauges will accurately display fuel pressure so you know exactly how your fuel system is pumping. Each gauge has an 1/8-NPT male filling on the back to thread to any 1/8-NPT port.



PN 80115

Stainless Steel Line Kits

These new kits are perfect for plumbing your car with beautiful, chemical resistant natural or black stainless steel braided fuel lines. These fuel lines and fittings are perfect for any fuel delivery application where you want to use pump gas, methanol, ethanol or alcohol. Plus they come with the best AN fittings around.

Kits include 20ft or 40ft natural stainless or black stainless braided hose with (3) 90 degree -6 AN fittings, (3) 45 degree -6 AN fittings and (6) straight -6 AN fittings with a 40 micron fuel filter and inline check valve.



PN 51001

Natural Stainless Steel Hose Kit

20ft, PN 51001

40ft, PN 51003

Black Stainless Steel Hose Kit

20ft, PN 51002

40ft, PN 51004

WARNING: Cancer or Reproductive Harm
www.P65warnings.ca.gov

Emission Controlled Vehicle Information: Not legal for use on Emissions Controlled Vehicles. Check with your local DMV, emissions testing facility or applicable State laws before installing.

27



USA 951-340-2624
CANADA 877-521-7787



sales@fitechefi.com



www.fitechefi.com

FiTech
Fuel Injection

ACCESSORIES

Throttle Body Gasket Kit, PN 60001

This kit includes both a 4150 and 4500 style base gasket as well as an air cleaner gasket.

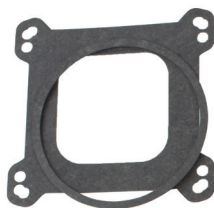

Throttle Return Spring, PN 60011

This kit includes a bracket that bolts to the throttle body and provides a throttle return spring. Note that this kit only fits the FiTech 4-barrel throttle bodies.



Oxygen Sensor Bung Kit, PN 60012

This kit makes installing the required WB02 sensor easy without welding. Simply drill a hole in your exhaust, install the gasket and sensor fitting and secure it with the supplied heavy duty band clamps.



Replacement Injectors

These injectors are replacements for the throttle body and port fuel injection systems.

- 5, 36-lb Injector, PN 10036
- 6, 55-lb Injector, PN 10055
- 3, 62-lb Injector, PN 10062
- 4, 80-lb Injector, PN 10080

Fuel Hose

Our fuel hose is rated to handle high pressure EFI applications and is engineered to handle today's fuel blends, race gas or methanol based fuels. Available in -6 (3/8") and -8 (1/2") sizes.

High Pressure Fuel Hose

- 5ft -6, PN 80150-5
- 10ft -6, PN 80150-10
- 20ft -6, PN 80150-20
- 25ft -6, PN 80150-25
- 5ft -8, PN 80151

28



WARNING: Cancer or Reproductive Harm
www.P65warnings.ca.gov

Emission Controlled Vehicle Information: Not legal for use on Emissions Controlled Vehicles. Check with your local DMV, emissions testing facility or applicable State laws before installing.

FiTech
Fuel Injection



USA 951-340-2624
CANADA 877-521-7787



sales@fitechefi.com



www.fitechefi.com

GO SPARK CDI Ignition

You've got the fuel, now upgrade the spark with our Go Spark Capacitive Discharge Ignition! The all new CDI delivers high powered sparks from idle to top rpm to improve the combustion even and power output of your engine.

The ignition produces a series of multiple sparks below 2,500 rpm to improve starting, idle quality and throttle response. At higher rpm, the CD technology continues to deliver full energy sparks through racing rpm to ensure complete combustion of the fuel mixture.

The Go-Spark CDI was designed for 4, 6 and 8-cylinder engines equipped with a distributor. It accepts the trigger signal from an HEI, amplifier, points or 2-wire non-magnetic pickup distributors. A separate 12 volt square wave tach output can be used to trigger the EFI system and/or a tach.

Go Spark CDI, PN 91000



A single connector is sealed and locked into the CDI making installation and routing of the harness much easier. There is also a separate 12-volt tach output wire that can trigger a tachometer or an EFI system.



SPECS

Spark Energy: 150mJ
Primary Voltage: 450
Spark Duration: 20-Degree
Multi-Spark to 2,500 rpm
Battery Supply: 6-18 Volts
Max RPM: 10,000

- High output multi-spark technology
- Optimized for EFI or carburetors
- One sealed connector for a clean installation
- Complete combustion results in improved driveability

 **WARNING:** Cancer or Reproductive Harm
www.P65warnings.ca.gov

Emission Controlled Vehicle Information: Not legal for use on Emissions Controlled Vehicles. Check with your local DMV, emissions testing facility or applicable State laws before installing.

29



USA 951-340-2624
CANADA 877-521-7787



sales@fitechefi.com



www.fitechefi.com

FiTech
Fuel Injection

Resources and Support

Not only do we have an experienced team of technicians available by phone or through email, but we also have a lot of helpful resources to help with your installation or setup questions.



The Tech Center page of our website (FiTechEFI.com) is loaded with quick, thorough tech videos that will answer many of the most common questions regarding installation, calibration and tuning. Be sure to take a look!

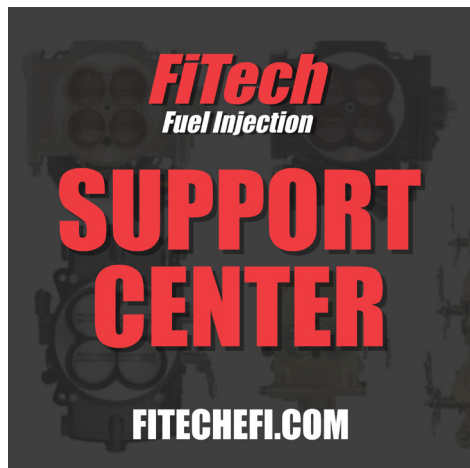

Have questions? We have techs ready to help you over the phone or through email. Please contact us at 951-340-2624 or write to info@fitechefi.com. Our team will get back with you ASAP.



Looking for a dealer or installer to help with your FiTech recommendation or installation? Our website can direct you towards assistance with a quick, effective zip code search.





Resources and Support

We want to ensure your installation goes well with any of our parts so you can get behind the wheel and enjoy the FiTech performance!



We've gathered a list of Frequently Asked Questions on our website that will likely have the answer to your question. Do I need to use timing control? Can I run a dual plane intake? What fuel pressure is required? All of these and many more are answered on our FAQ.

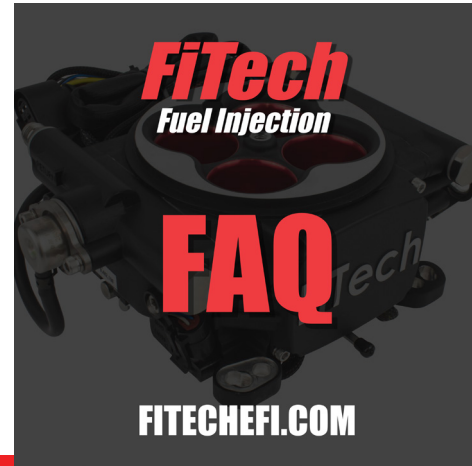

Our instructions provide thorough details to assist during the installation process. If you need a fresh set of instructions you can easily download them from our website.

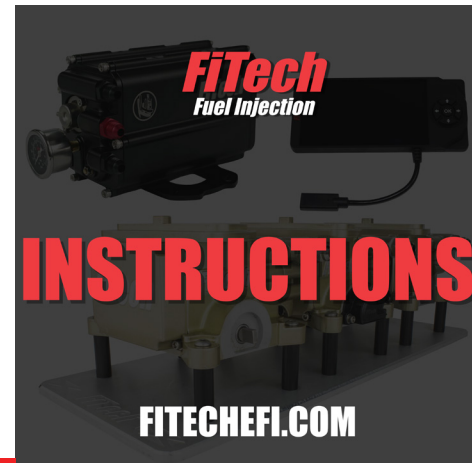

We also provide a lot of links to media installations, tips and product information from websites, magazines, social media posts, and other fun posts and cool news.





FiTech



951-340-2624



sales@fitechefi.com



www.fitechefi.com

12370 Doherty Street, Suite A, Riverside, California 92503