

1998-2002 GM F-BODY CAMARO / TRANS AM - V8 5.7L

Warning: When working on, under, or around any vehicle exercise caution. Please allow the vehicle's exhaust system to cool before removal, as exhaust system temperatures may cause severe burns. If working without a lift, always consult vehicle manual for correct lifting specifications. Always wear safety glasses and ensure a safe work area. Serious injury or death could occur if safety measures are not followed.

Step 1: (Carefully read all instructions before installation)

Disconnect the vehicle's battery before removal of the OEM exhaust. This will allow the computer to reset itself with the new system, and prevent electrical accidents. To remove the OEM exhaust system you will need to cut the OEM over-axle pipe just in front of the rear axle. Unbolt all hangers on the tailpipes and muffler, then remove from the vehicle (Do not damage the OEM rubber insulators or discard the OEM fasteners as they will be re-used to mount the new system.) Unbolt the clamp where the OEM middle pipe meets the catalytic converter extension and remove the pipe from the vehicle.

Step 2: Layout all parts of the new system as shown in the diagram. Install the tailpipe hanger brackets (See diagram 2 for installation of hanger brackets.) Install the new mid-pipe using the supplied 2.75" clamp (Leave all clamps and fasteners loose for final adjustment of the complete system.) Working rearward, install the over-axle pipe using the supplied clamps, and the OEM fasteners from the hangers. Install the tailpipes by fitting the welded hangers into the rubber insulators. Mount the muffler to the over-axle pipe and the tailpipes using the supplied clamps and rubber insulators. You can now install and align the tips using the supplied 2.50" clamps.

Step 3: With all components mounted loosely, adjust the system for overall aesthetics and clearance of frame & bodywork. (MAGNAFLOW recommends at least 1/2" of clearance between the exhaust system and any body panels to prevent heat-related body damage or fire.)

Step 4: Once a final position has been chosen for the new system, evenly tighten all fasteners from front to rear (The supplied band clamps must be very tight, 40ft-lbs, to work properly). You can now connect the battery, start the vehicle, and check for leaks. Inspect all fasteners after 25-50 miles of operation and retighten if necessary.

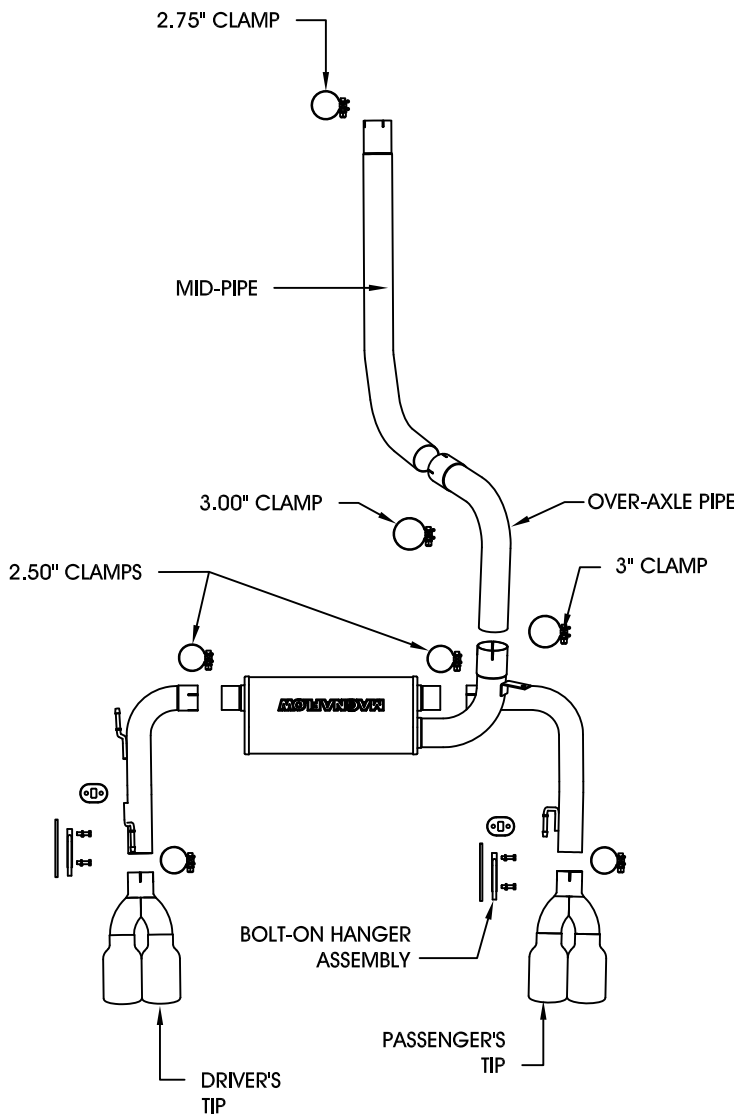

*MAGNAFLOW Performance Exhaust recommends professional installation on all their products

Technical support: 1-800-959-9226 ext. 4500

MAGNAFLOW Performance Exhaust - 22961 Arroyo Vista - Rancho Santa Margarita, CA 92688

1998-2002 GM F-BODY CAMARO / TRANS AM - V8 5.7L

Warning: When working on, under, or around any vehicle exercise caution. Please allow the vehicle's exhaust system to cool before removal, as exhaust system temperatures may cause severe burns. If working without a lift, always consult vehicle manual for correct lifting specifications. Always wear safety glasses and ensure a safe work area. Serious injury or death could occur if safety measures are not followed.

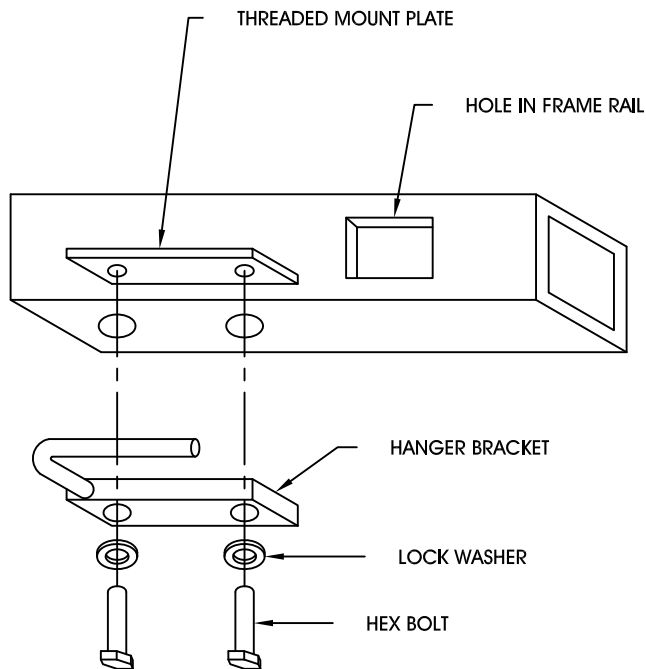

Hanger Brackets: Slide the threaded mount plate into the pre-cut holes in the frame. Position the threaded mount plate in the frame until the threaded holes of the mount plate are lined up with the pre-cut holes in the frame, with the threaded pem-nuts facing upwards. Fasten the hanger brackets to the frame using the supplied fasteners in the order shown in the diagram. The welded hanger should face forward and to the center of the vehicle. Fit the supplied rubber insulators onto the hanger, then fit the welded hangers of the tailpipes to the rubber insulators.