



LEGAL IN CALIFORNIA ONLY FOR RACING VEHICLES WHICH MAY NEVER BE USED, REGISTERED OR LICENSED FOR USE UPON A HIGHWAY. See knfilters.com for CARB status on each part for a specific vehicle

INSTALLATION INSTRUCTIONS

77-9037KP TOYOTA 2012-15 Tacoma V6-4.0L

NOTE: This kit was not designed to fit vehicles with a body lift.

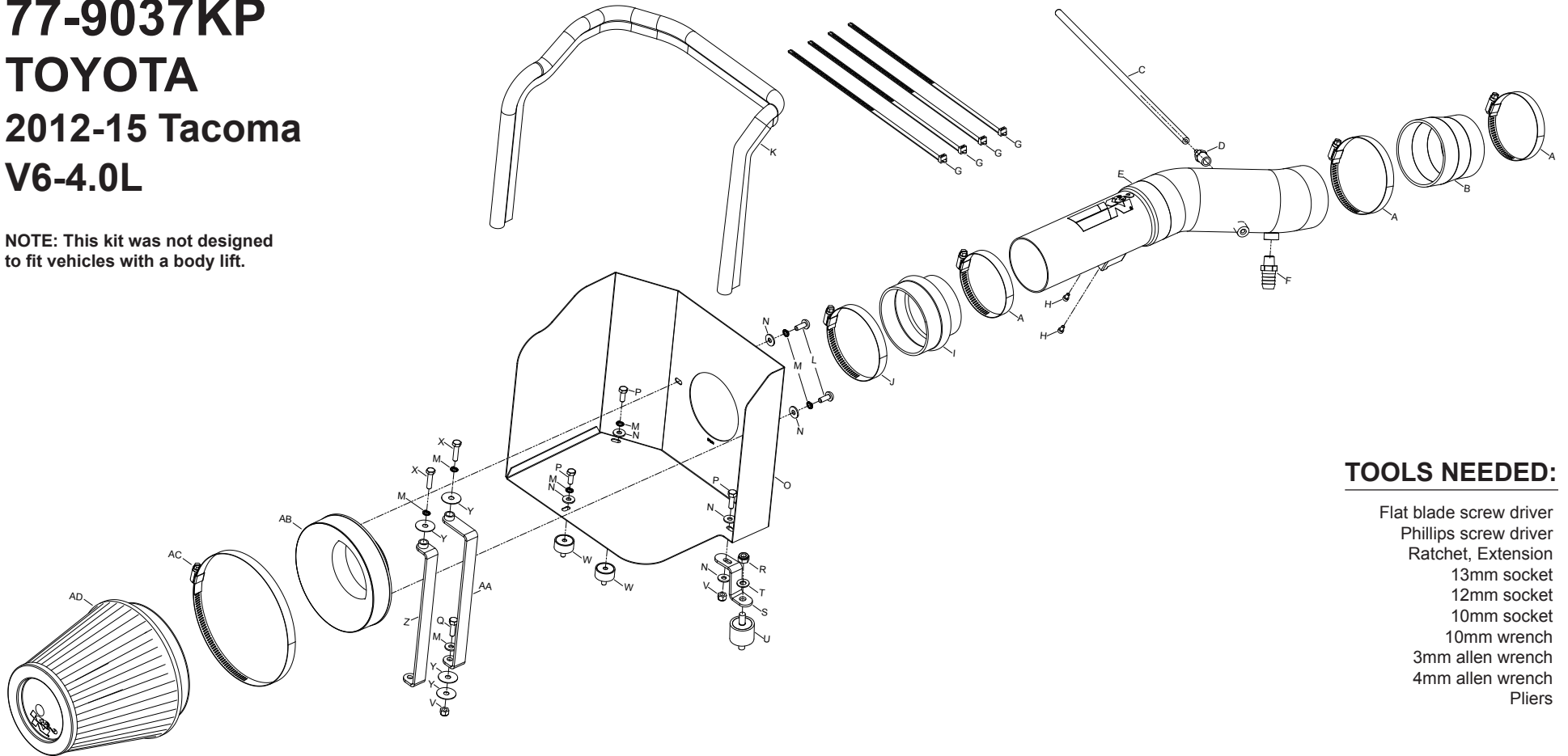

TOOLS NEEDED:

Flat blade screw driver
Phillips screw driver
Ratchet, Extension
13mm socket
12mm socket
10mm socket
10mm wrench
3mm allen wrench
4mm allen wrench
Pliers

PARTS LIST:

Description	Qty.	Part #	Description	Qty.	Part #	Description	Qty.	Part #
A Hose Clamp #48	3	08601	K Edge Trim (39")	1	102496	U Stud; Rubber Mounted M/M 1.25-1"L	1	070227
B Hose; 3-1/4" To 3" ID X 3"L TPRD Reinforced	1	08429	L Bolt; M6 X 1.00 X 16MM, Buttonhead, SS	2	07730	V Nut; 6MM Nylock, Hexhead, SS	2	07512
C Hose; 4MM ID X 18"L	1	08153	M Washer; M6 Split Lock Zinc	6	1-3025	W Stud; Rubber MNT, M/F, 1/2"L X 1"W	2	070228
D Vent; STRT, 3/16 Barbed 1/4"NPT, Nylon	1	080021	N Washer; 6MM Flat, SS	7	08269	X Bolt; m6-1.00 X 25MM, SS	2	07858
E Intake Tube	1	27578KP	O Heat Shield	1	07394	Y Washer; 1"D X 1/4 Hole Fender	4	08160
F Vent; STRT, 5/8 Barbed 1/4 NPT, Nylon	1	08911	P Bolt; 6MM-1.00 X 16MM, SS	3	07812	Z Bracket; "C", 63-9037, STL, TB/PC	1	083168
G Cable Ties; 11" Black	4	21590	Q Bolt; M6 X 1.00" X 20MM Hex, SS	1	07795	AA Bracket; "C", 63-9037, STL, TB/PC	1	083169
H Bolt; M4-0.07 8MM, A/H Cap, SS	2	07733	R Nut; 8MM Nylock, SS	1	07502	AB Adapter; Universal, 6" Filter 3.5" Coupler	1	21512-1
I Hose; 3-1/2" To 3" ID X 2-1/2"L Hump	1	084079	S Bracket; 57-2507, Short "Z", Fin, TB/PC	1	07958	AC Hose Clamp #104	1	08697
J Hose Clamp #56	1	08620	T Washer; 5/16"ID X 5/8"OD, Flat	1	08276	AD Air Filter	1	RF-1042XD

NOTE: FAILURE TO FOLLOW INSTALLATION INSTRUCTIONS AND NOT USING THE PROVIDED HARDWARE MAY DAMAGE THE INTAKE TUBE, THROTTLE BODY AND ENGINE.

TO START:

1. Turn off the ignition and disconnect the negative battery cable.

NOTE: Disconnecting the negative battery cable erases pre-programmed electronic memories. Write down all memory settings before disconnecting the negative battery cable. Some radios will require an anti-theft code to be entered after the battery is reconnected. The anti-theft code is typically supplied with your owner's manual. In the event your vehicles' anti-theft code cannot be recovered, contact an authorized dealership to obtain your vehicles anti-theft code.



2. Remove the two nuts which secure the engine cover and then lift off the engine cover.



3. Release the spring clamp securing the secondary air hose and then disconnect the secondary air hose.

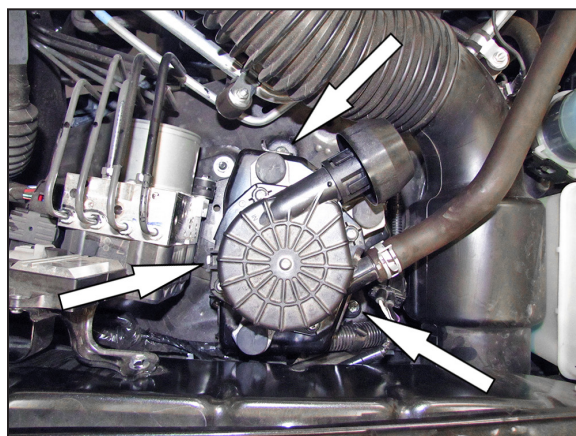

4. Remove the three bolts securing the secondary air pump and then disconnect the electrical connection and remove the secondary air pump from the engine compartment.



5. Loosen the hose clamp securing the intake tube to air filter housing.

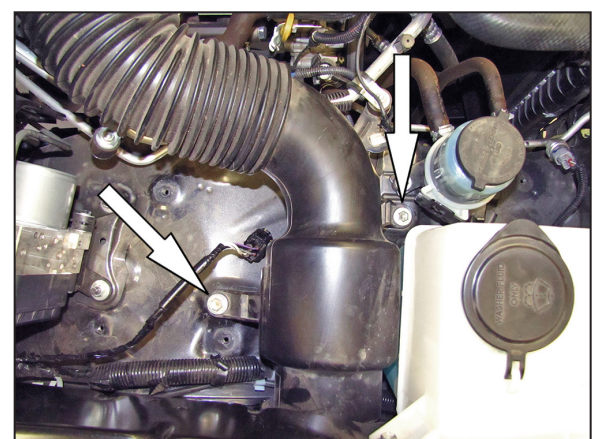

6. Remove the two bolts securing the intake resonator to the inner fender and then remove the intake tube/resonator assembly from the engine compartment.



7. Loosen the hose clamp securing the intake hose to the throttle body.

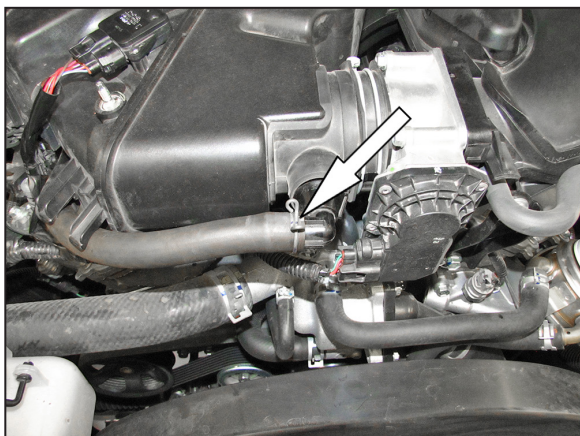

8. Release the spring clamp securing the crank case vent hose and then disconnect the crank case vent hose.

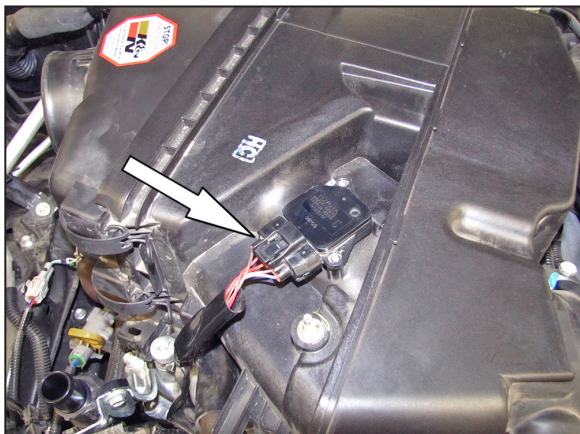

9. Disconnect the mass air sensor electrical connection and unhook the wiring harness from the air filter housing.



10. Remove the two bolts securing the air filter housing to the engine and then remove the air filter housing from the engine.

NOTE: The fuel pressure regulator vent hose will need to be disconnected as the housing is lifted up.
NOTE: K&N Engineering, Inc., recommends that customers do not discard factory air intake.

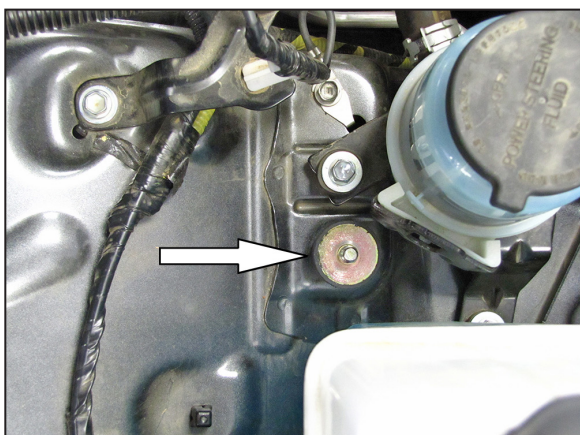

11. Install the provided 8mm rubber mounted stud into the intake resonator mounting location as shown.

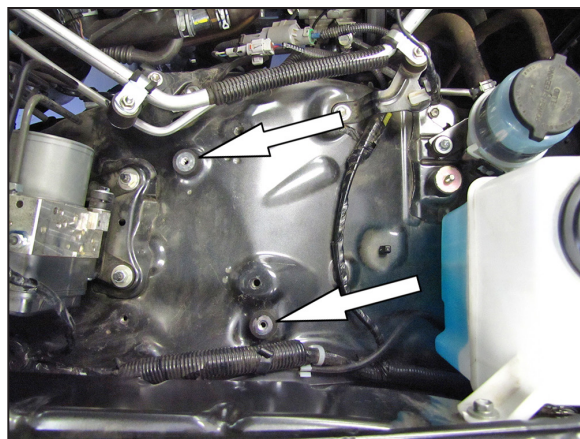

12. Install the two remaining 6mm rubber mounted studs into the secondary air injection pump mounting locations.

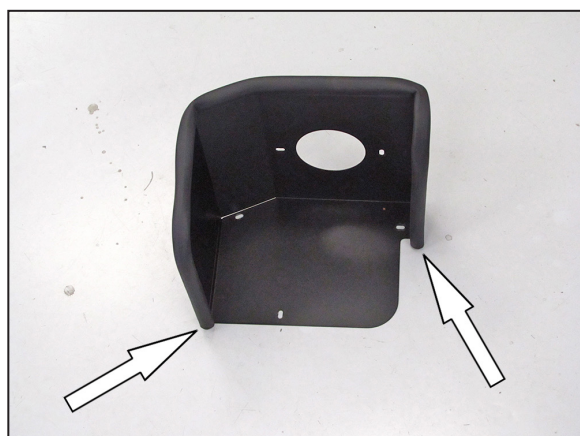

13. Install the provided edge trim onto the heat shield as shown.

NOTE: Some trimming of the edge trim will be necessary.



14. Install the filter adapter into the heat shield and secure with the provided hardware.

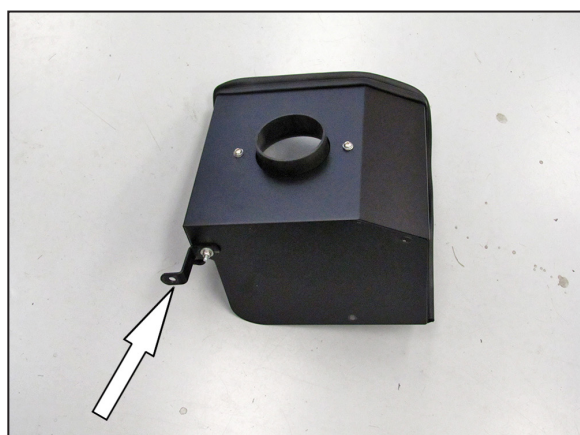

15. Install the heat shield mounting bracket (07958) onto the heat shield as shown using the provided hardware.

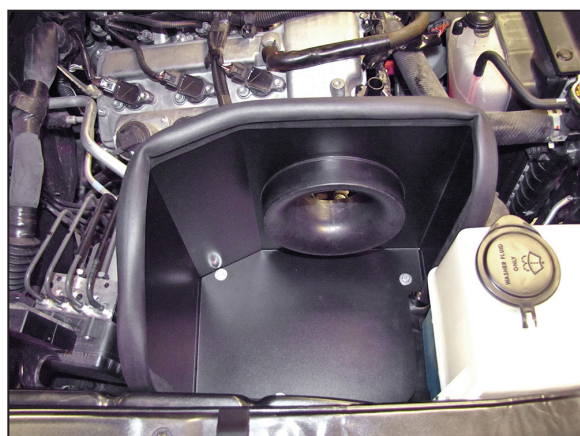

16. Set the heat shield into position on the rubber mounted studs and then secure with the provided hardware.

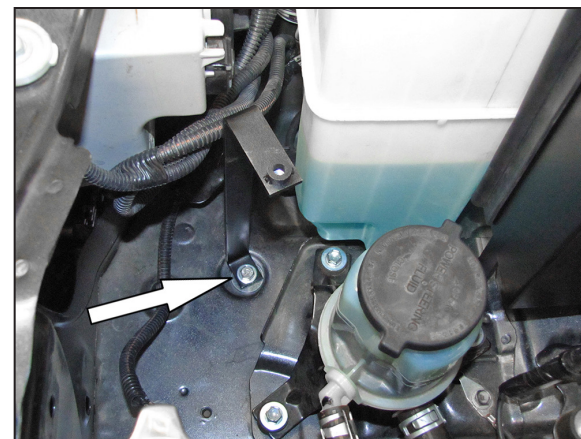

17. Install the provided secondary air pump mounting bracket (083169) onto the inner fender using the provided hardware.

NOTE: The nut and washer will be accessed from the underside of the fender.

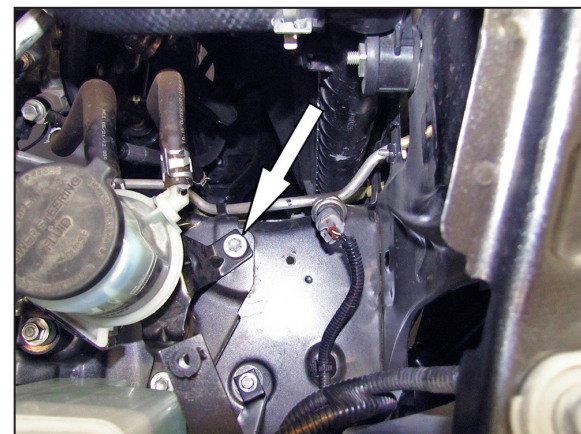

18. Remove the power steering reservoir mounting bolt shown.

NOTE: This bolt will be reused in the next step.

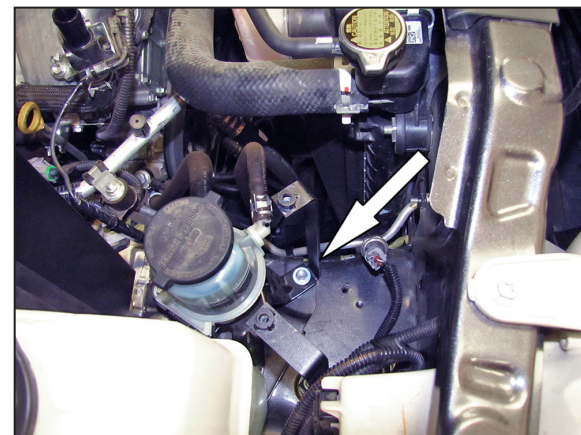

19. Install the provided secondary air pump mounting bracket (083168) onto the power steering reservoir using the bolt from the previous step.



20. Separate the secondary air pump motor from the mounting bracket.



21. Install the secondary air pump onto the brackets previously installed and secure with the provided hardware. Reconnect the secondary air hose to the fitting and secure with the factory spring clamp.

NOTE: Adjust the hose so that it does not collapse or kink.

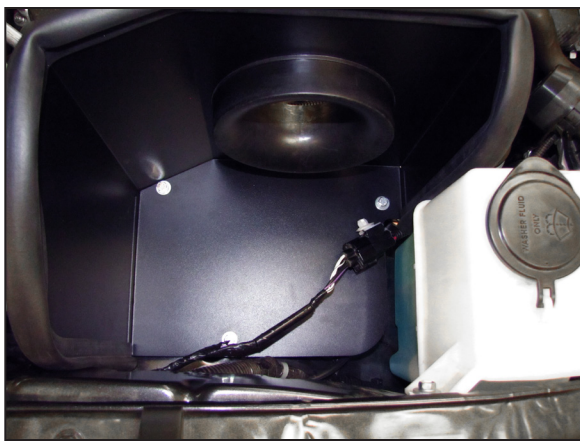

22. Route the secondary air wiring harness through the heat shield and reconnect the electrical connection.

NOTE: Due to manufacturing tolerances, it may be necessary to clip the wiring harness retaining ties so that the harness can be adjusted for clearance around the heat shield and washer bottle. Use the provided tie wraps to secure the wiring harness.



23. Install the provided silicone hose (08429) onto the throttle body and secure with the provided hose clamp.

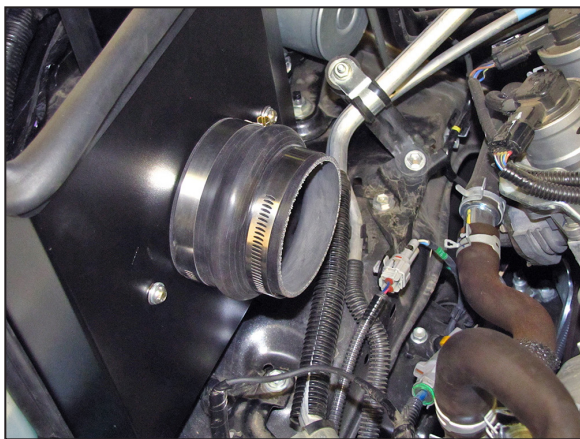

24. Install the provided silicone hose (084079) onto the filter adapter and secure with the provided hose clamp.

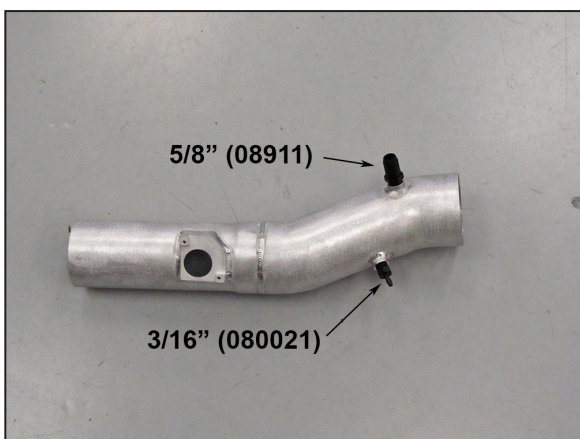

25. Install the provided vent fittings into the K&N® intake tube as shown.

NOTE: Plastic NPT fittings are easy to cross thread. Install the vent fitting "hand" tight, then turn it two complete turns with a wrench.

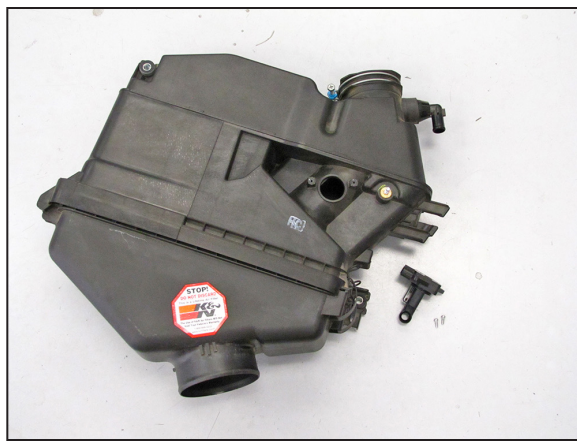

26. Remove the two screws securing the mass air sensor into the air filter housing and then remove the mass air sensor from the housing.

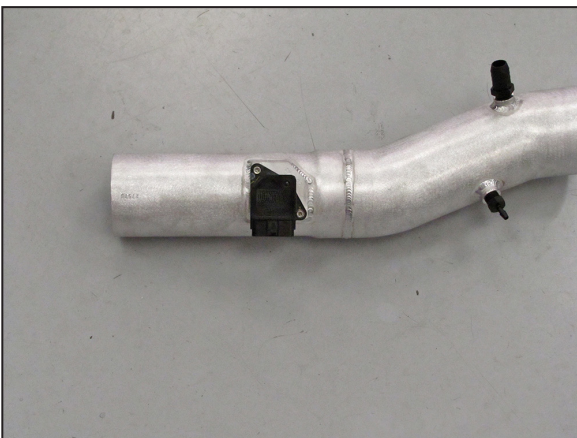

27. Install the mass air sensor into the K&N® intake tube and secure with the provided hardware.



28. Install the K&N® intake tube into the silicone hose at the filter adapter far enough to gain clearance into the silicone hose at the throttle body, then install the tube into the throttle body silicone hose and secure it with the provided hose clamps. **NOTE:** Do not completely tighten at this time.

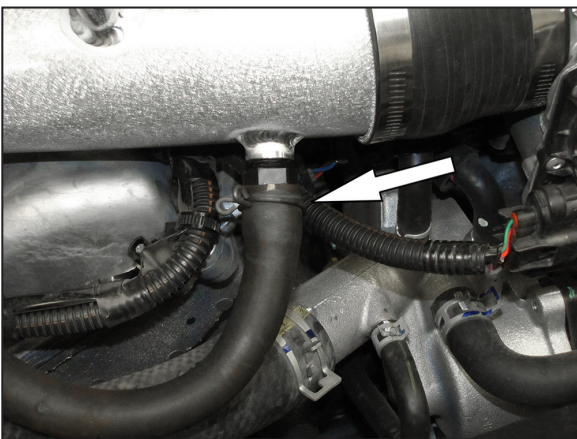

29. Connect the crank case vent hose to the fitting installed into the K&N® intake tube.

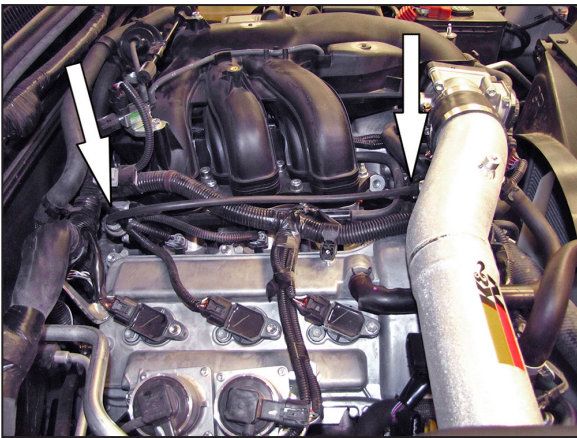

30. Connect the provided fuel pressure vent hose to the fuel pressure regulator and then connect the open end to the fitting installed into the K&N® intake tube.

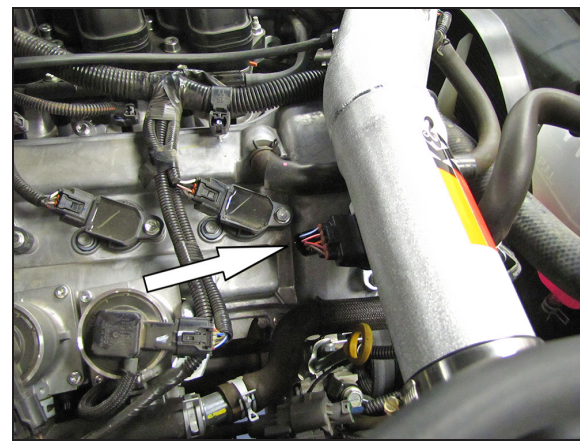

31. Reconnect the mass air sensor electrical connection.

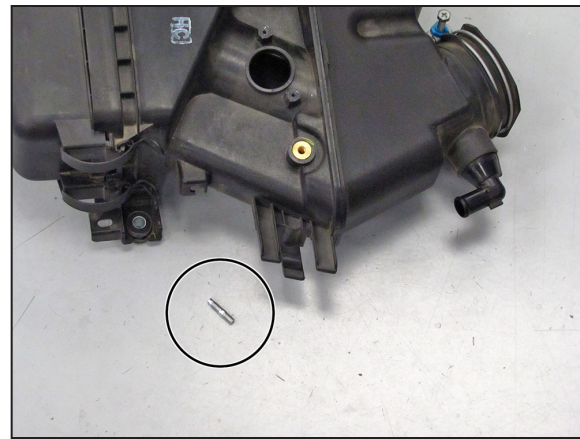

32. Remove the engine cover mounting stud from the air filter housing.

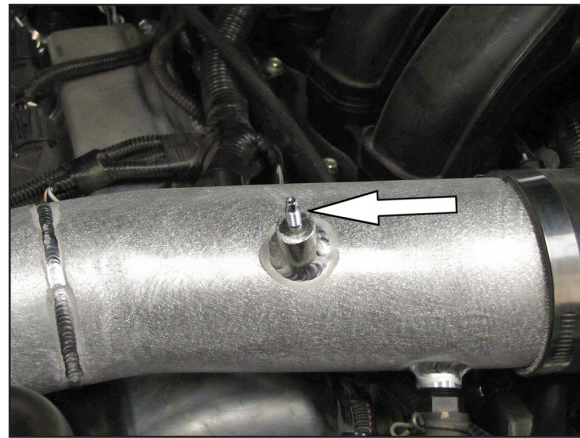

33. Install the engine cover mounting stud into the K&N® intake tube.

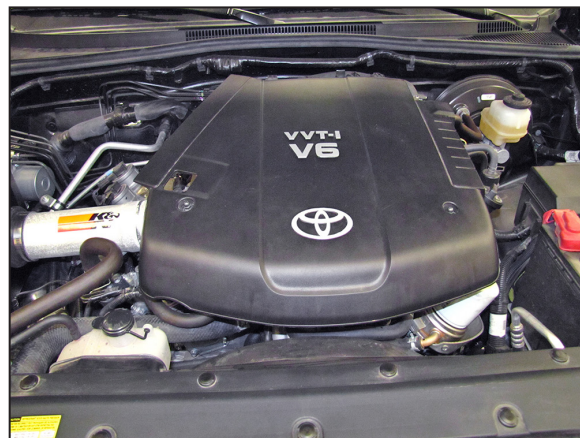

34. Install the engine cover secure with the factory retaining nuts.

NOTE: Adjust the K&N® intake tube as necessary so that the stud is in the proper location for the cover, and then tighten the hose clamps securing the intake tube.

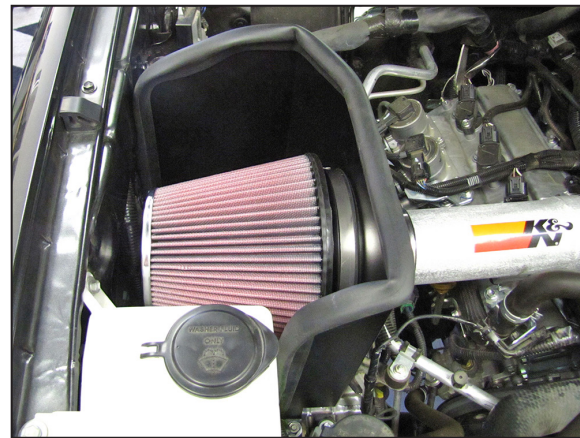

35. Install the K&N® air filter and secure with the provided hose clamp. **NOTE:** Drycharger® air filter wrap; part # RF-1042DK is available to purchase separately. To learn more about Drycharger® filter wraps or look up color availability please visit <http://www.knfilters.com>.

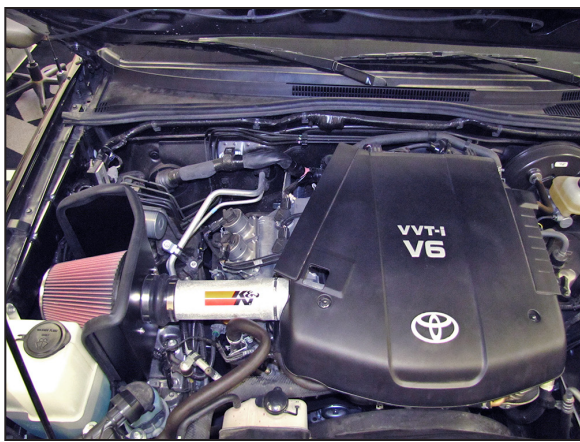

36. Reconnect the vehicle's negative battery cable. Double check to make sure everything is tight and properly positioned before starting the vehicle.

37. It will be necessary for all K&N® high flow intake systems to be checked periodically for realignment, clearance and tightening of all connections. Failure to follow the above instructions or proper maintenance may void warranty.

ROAD TESTING:

1. Start the engine with the transmission in neutral or park, and the parking brake engaged. Listen for air leaks or odd noises. For air leaks secure hoses and connections. For odd noises, find cause and repair before proceeding. This kit will function identically to the factory system except for being louder and much more responsive.

2. Test drive the vehicle. Listen for odd noises or rattles and fix as necessary.

3. If road test is fine, you can now enjoy the added power and performance from your kit.

4. K&N Engineering, Inc., requires cleaning the intake system's air filter element every 100,000 miles. When used in dusty or off-road environments, our filters will require cleaning more often. We recommend that you visually inspect your filter once every 25,000 miles to determine if the screen is still visible. When the screen is no longer visible some place on the filter element, it is time to clean it. To clean and re-oil, purchase our filter Recharger® service kit, part number 99-5050 or 99-5000 and follow the easy instructions.

**LEGAL IN CALIFORNIA ONLY FOR RACING VEHICLES
WHICH MAY NEVER BE USED, REGISTERED
OR LICENSED FOR USE UPON A HIGHWAY.**

See knfilters.com for CARB status on each part for a specific vehicle