



TYPHOON INTAKE SYSTEMS

LEGAL IN CALIFORNIA ONLY FOR RACING VEHICLES WHICH MAY NEVER BE USED, REGISTERED OR LICENSED FOR USE UPON A HIGHWAY. See knfilters.com for CARB status on each part for a specific vehicle

INSTALLATION INSTRUCTIONS

69-8617TTK
TOYOTA
2010-11 Camry
L4-2.5L
2013-15 Venza
L4-2.7L

TOOLS NEEDED:

- 3mm Allen Wrench
- 10mm Socket
- 17mm Socket
- 10mm Wrench
- Extension
- Flat Blade Screwdriver
- Phillips Screwdriver
- Ratchet

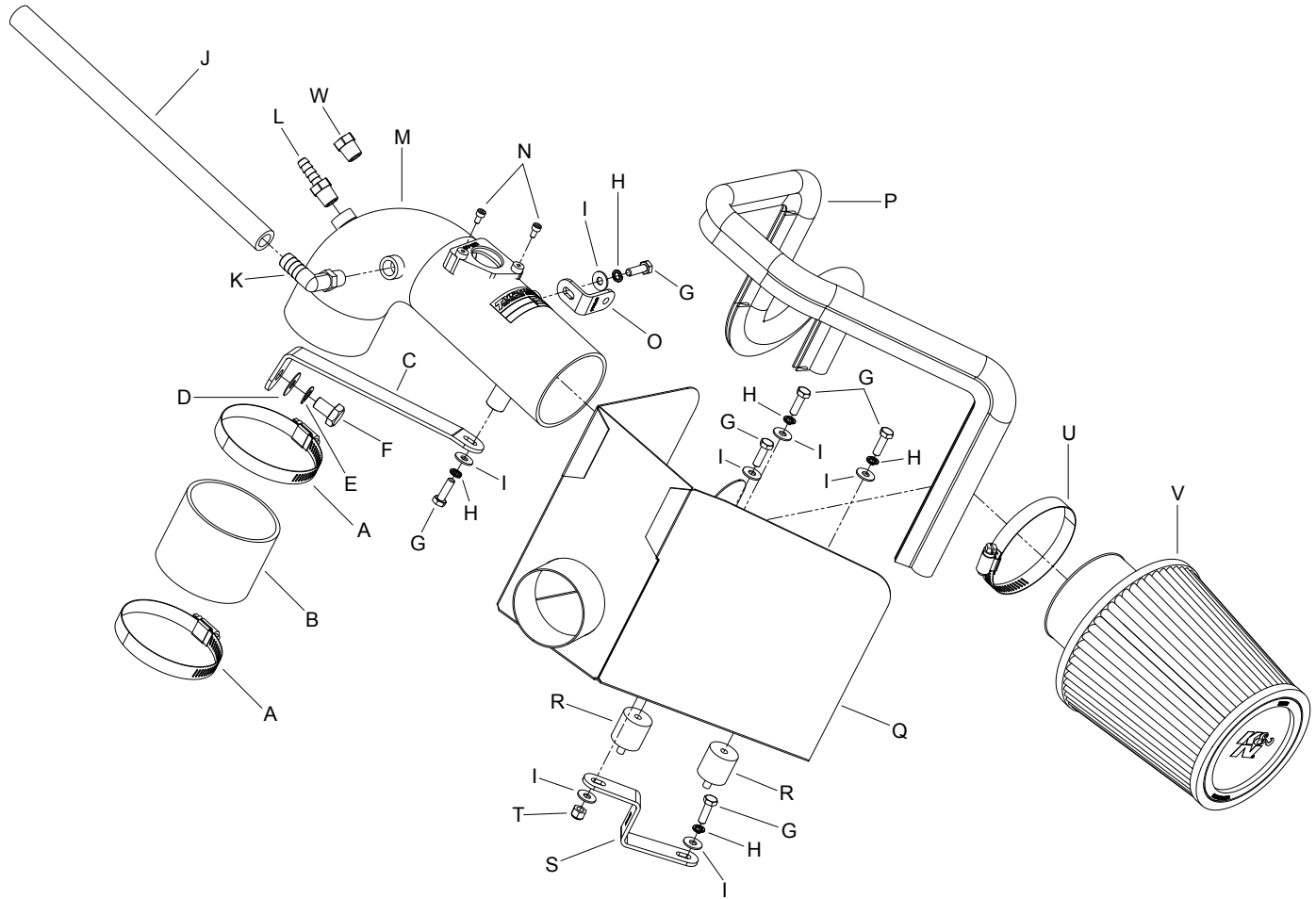

PARTS LIST:

Description	Qty.	Part #	Description	Qty.	Part #	Description	Qty.	Part #
A Hose Clamp #48	2	08601	I Washer; 6mm Flat, SS	7	08269	Q Heat Shield	1	07647
B Hose; 3" ID X 2-1/2" L Reinforced	1	08192	J Hose, 1/2" ID X 12"L	1	087031	R Stud; Rubber Mount, M6 X 1, 1" T, M/F	2	02033
C Bracket; "L", STL, TB/PC	1	083162	K Vent; 90DEG, 1/2" Hose, 1/4" NPT, Black	1	08110FK	S Bracket; "Z", STL, TB/PC	1	26655
D Washer; 3/8" Flat Washer, SS	1	08134	L Vent; STRT, 5/16" Barbed, 1/4 NPT, Nylon	1	08908	T Nut; 6mm Nylock, Hexhead, SS	1	07512
E Washer; 10mm Wave	1	08175	M Intake Tube	1	27544	U Hose Clamp #52	1	08610
F Bolt; M10-1.25 X 16mm Hex Head,SS	1	071002	N Bolt; M4- 0.07 8mm, A/H Cap, SS	2	07733	V Air Filter	1	RU-4990
G Bolt; 6mm-1.00 X 16mm, SS	6	07812	O Bracket; "L", SML, STL, TB/PC	1	070066	W Plug	1	08032
H Washer, M6 Split Lock Zinc	5	1-3025	P Edge Trim (39")	1	102496			

NOTE: FAILURE TO FOLLOW INSTALLATION INSTRUCTIONS AND NOT USING THE PROVIDED HARDWARE MAY DAMAGE THE INTAKE TUBE, THROTTLE BODY AND ENGINE.

TO START:

1. Turn off the ignition and disconnect the negative battery cable.
NOTE: Disconnecting the negative battery cable erases pre-programmed electronic memories. Write down all memory settings before disconnecting the negative battery cable. Some radios will require an anti-theft code to be entered after the battery is reconnected. The anti-theft code is typically supplied with your owner's manual. In the event your vehicles' anti-theft code cannot be recovered, contact an authorized dealership to obtain your vehicles anti-theft code.

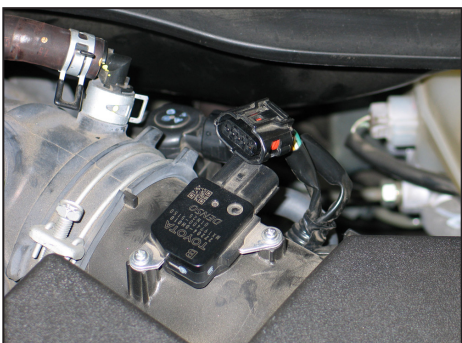

2. Disconnect the mass air sensor electrical connection.



3. Lift up and remove the engine cover.



4. Disconnect the crank case vent hose from the valve cover as shown.



5. Disconnect the EVAP vent line from the factory intake tube as shown.

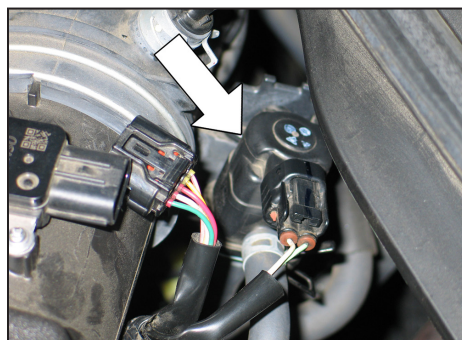

6. Lift up and remove the EVAP solenoid from the rear of the factory intake tube.

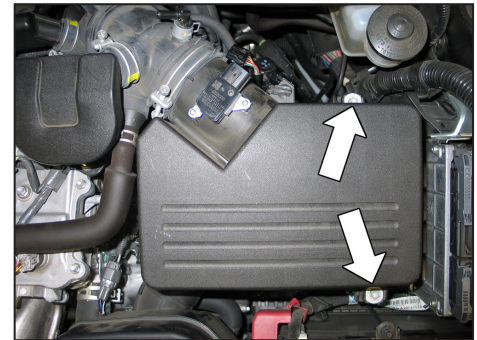

7. Loosen the two upper air box mounting bolts shown.



8. Loosen the hose clamp that secures the factory intake tube to the throttle body and then remove the intake tube and upper air box assembly.

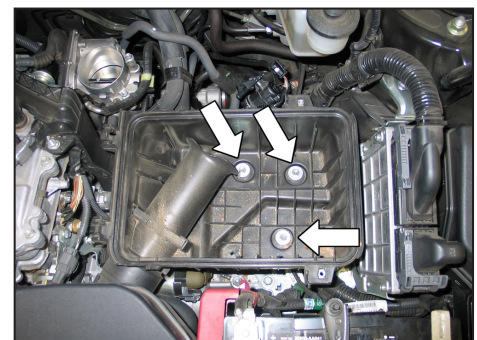

9. Remove the three lower air box mounting bolts and then remove the lower air box housing from the vehicle.

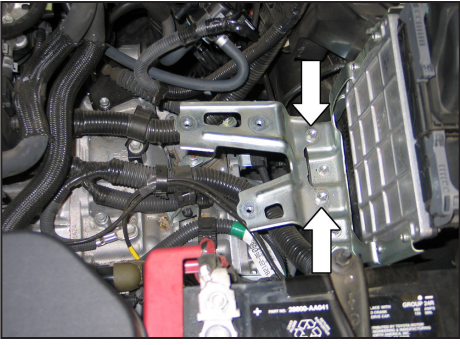

10. Remove the two air box mounting bracket bolts and then remove the bracket from the vehicle.

NOTE: Both the bolts and bracket will be reused.

NOTE: K&N Engineering, Inc., recommends that customers do not discard factory air intake.

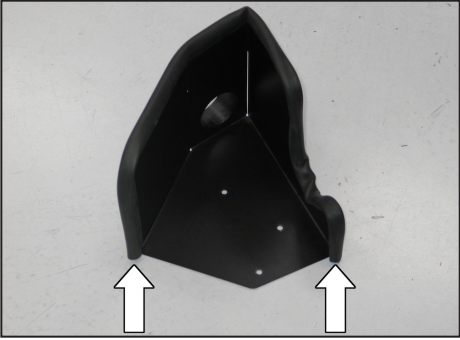

11. Install the provided edge trim onto the heat shield as shown.

NOTE: Trimming of the edge trim will be necessary.

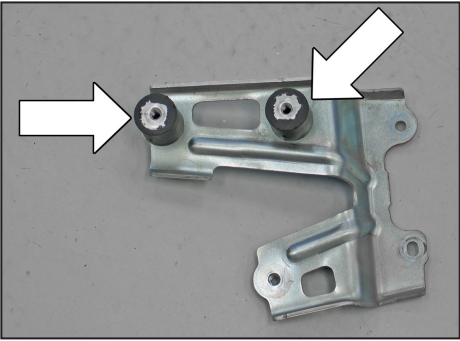

12. Install the two provided rubber mounted studs onto the factory air box bracket as shown.

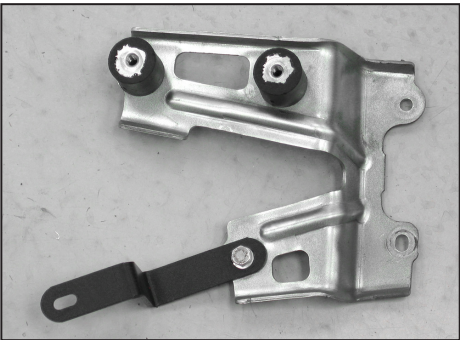

13. Install the heat shield mounting bracket (26655) onto the air box mounting bracket as shown.

NOTE: The long leg of the bracket is attached to the bracket.

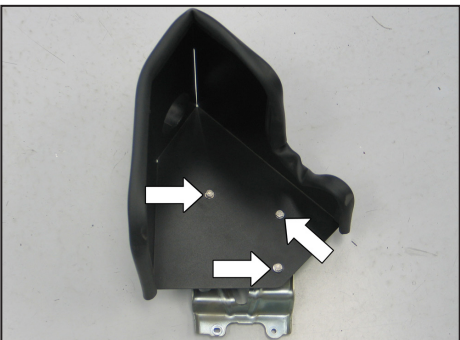

14. Attach the air box bracket assembly to the K&N® heat shield as shown using the provided hardware.

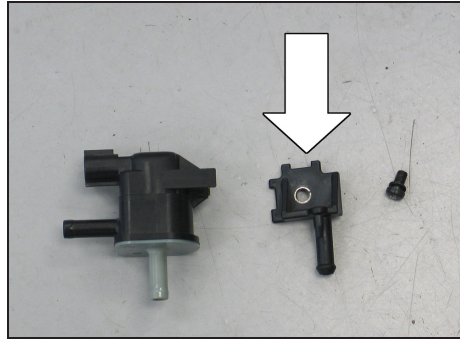

15. On vehicles equipped with EVAP valve, remove the EVAP control valve mounting bracket from the EVAP control valve.

NOTE: The EVAP control valve was removed from the vehicle for picture purpose, it is not necessary to remove the EVAP control valve from the vehicle to remove the mounting bracket. The mounting bolt will be reused.

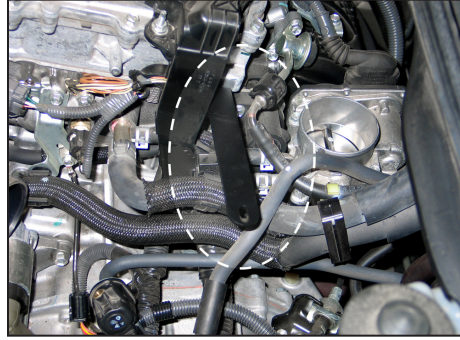

16. Install the tube mounting bracket (083162) onto the cylinder head as shown using the provided hardware.



17. Install the provided silicone hose (08192) onto the throttle body and secure with the provided hose clamp.

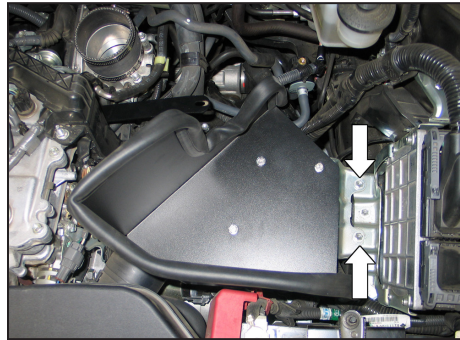

18. Install the heat shield assembly into the vehicle and secure with the factory air box mounting bracket bolts.

NOTE: Be sure to attach the fresh air intake to the tube on the heat shield.

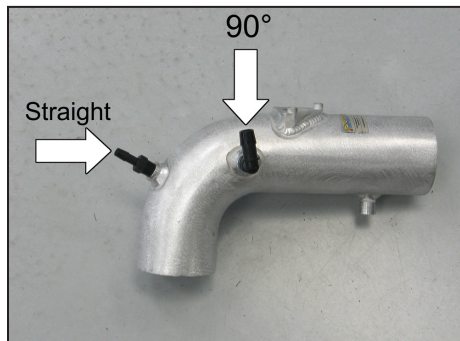

19. Install the two provided 1/4" NPT fittings into the K&N® intake tube as shown.

NOTE: On vehicle that are not equipped with an EVAP line, Install the provided 1/4 NPT plug in place of the vent fitting.

NOTE: Plastic NPT fittings are easy to cross thread. Install the vent fitting "hand" tight, then turn it two complete turns with a wrench.

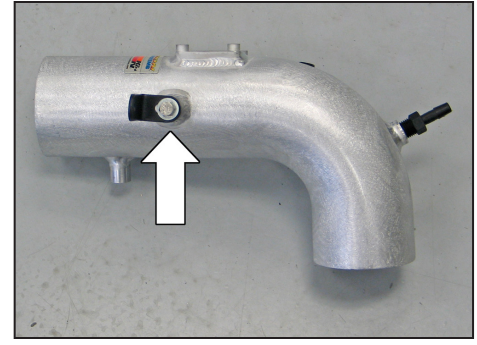

20. On vehicles equipped with EVAP valve, install the provided EVAP mounting bracket (070066) onto the K&N® intake tube using the provided hardware.

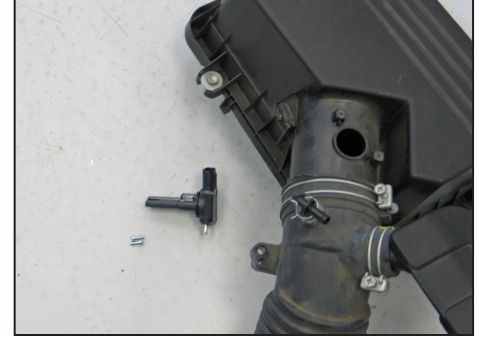

21. Remove the mass air sensor from the factory upper air box.

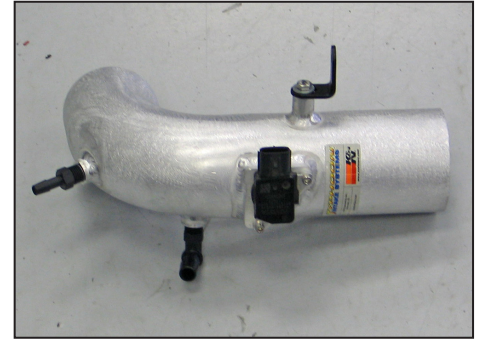

22. Install the mass air sensor into the K&N® intake tube and secure with the provided hardware.



23. Install the K&N® intake tube into the silicone hose at the throttle body and align with the mounting bracket previously installed. Secure the tube with the provided hose clamp and hardware.



24. On vehicles equipped with EVAP valve, attach the EVAP solenoid to the bracket installed onto the K&N® intake tube and secure with the factory screw.

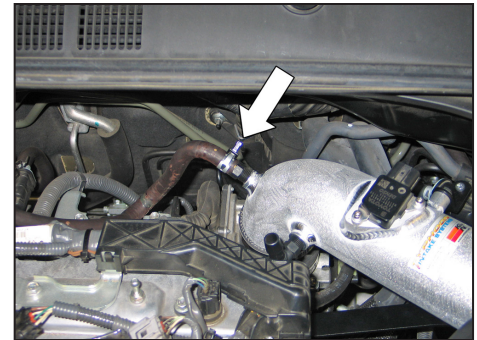

25. On vehicles equipped with EVAP valve, attach the EVAP vent line to the straight fitting installed in the K&N® intake tube.

NOTE: The EVAP vent line may be trimmed if desired.

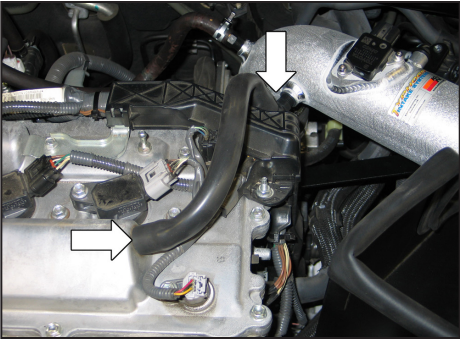

26. Attach the provided crank case vent hose to the 90° vent fitting in the K&N® intake tube and to the valve cover port as shown.



27. Install the K&N® air filter onto the intake tube and secure with the provided hose clamp.
NOTE: Drycharger® air filter wrap; part # RX-4990DK is available to purchase separately. To learn more about Drycharger® filter wraps or look up color availability please visit <http://www.knfilters.com>®.



28. Reconnect the mass air sensor electrical connection.



29. Reinstall the engine cover.

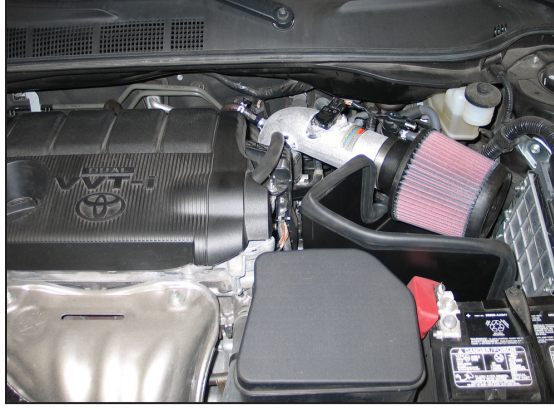

30. Reconnect the vehicle's negative battery cable. Double check to make sure everything is tight and properly positioned before starting the vehicle.

31. It will be necessary for all K&N® high flow intake systems to be checked periodically for realignment, clearance and tightening of all connections. Failure to follow the above instructions or proper maintenance may void warranty.

ROAD TESTING:

1. Start the engine with the transmission in neutral or park, and the parking brake engaged. Listen for air leaks or odd noises. For air leaks secure hoses and connections. For odd noises, find cause and repair before proceeding. This kit will function identically to the factory system except for being louder and much more responsive.

2. Test drive the vehicle. Listen for odd noises or rattles and fix as necessary.

3. If road test is fine, you can now enjoy the added power and performance from your kit.

4. K&N Engineering, Inc., requires cleaning the intake system's air filter element every 100,000 miles. When used in dusty or off-road environments, our filters will require cleaning more often. We recommend that you visually inspect your filter once every 25,000 miles to determine if the screen is still visible. When the screen is no longer visible some place on the filter element, it is time to clean it. To clean and re-oil, purchase our filter Recharger® service kit, part number 99-5050 or 99-5000 and follow the easy instructions.

**LEGAL IN CALIFORNIA ONLY FOR RACING VEHICLES
WHICH MAY NEVER BE USED, REGISTERED
OR LICENSED FOR USE UPON A HIGHWAY.**

See knfilters.com for CARB status on each part for a specific vehicle