



TYPHOON INTAKE SYSTEMS

INTAKE SYSTEMS FOR VEHICLES LISTED ARE 50 STATE LEGAL. SEE KNFILTERS.COM FOR CARB STATUS ON EACH PART FOR A SPECIFIC VEHICLE.

INSTALLATION INSTRUCTIONS

69-8001TS
SUBARU
2004-07 Impreza WRX STi
H4-2.5L Turbo
2006-07 Impreza WRX
H4-2.5L Turbo
2002-05 Impreza WRX
H4-2.0L Turbo

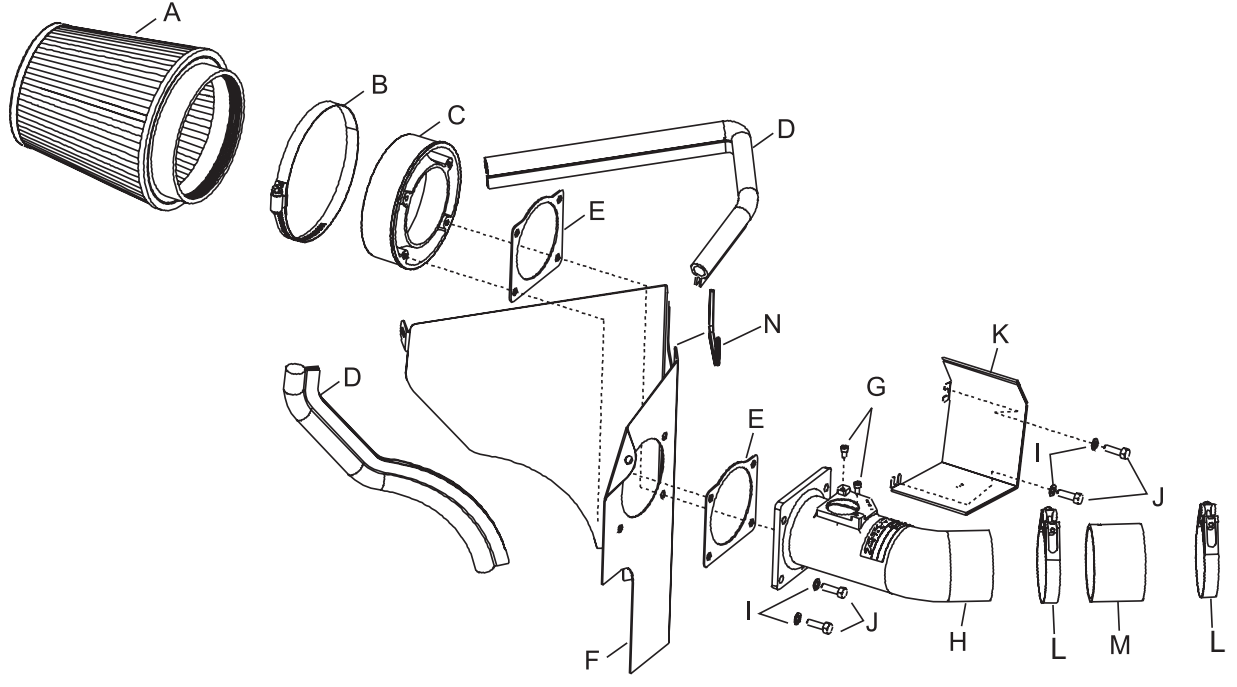

PARTS LIST:

Description	Qty.	Part #
A Air Filter	1	RP-5113
B Hose Clamp #80	1	08694
C Adaptor; #350	1	21510
D Edge Trim; Top-Loc 32"L	1	102493
E Gasket; 63-1034; 1/16" Neoprene	2	09202
F Heat Shield; 69-8001	1	07328
G Bolt; M4 x 8MM, C/H/A	2	07733
H Turbo Inlet Tube	1	27171
I Washer; 6MM Wave	4	08277
J Bolt; M6 x 20MM, Hex., SS	4	07795
K Heat Insulation Plate	1	03467
L Hose Clamp; #44	2	08560
M Hose; 2-3/4"ID x 2"L, Blk.	1	08440
N Edge Trim	1	102452

TOOLS NEEDED:
Flat Blade Screwdriver
Ratchet
8" Extension
10mm Socket
12mm Socket

NOTE: FAILURE TO FOLLOW INSTALLATION INSTRUCTIONS AND NOT USING THE PROVIDED HARDWARE MAY DAMAGE THE INTAKE TUBE, THROTTLE BODY AND ENGINE.

TO START:

1. Turn off the ignition and disconnect the negative battery cable.
NOTE: Disconnecting the negative battery cable erases pre-programmed electronic memories. Write down all memory settings before disconnecting the negative battery cable. Some radios will require an anti-theft code to be entered after the battery is reconnected. The anti-theft code is typically supplied with your owner's manual. In the event your vehicles' anti-theft code cannot be recovered, contact an authorized dealership to obtain your vehicles anti-theft code.

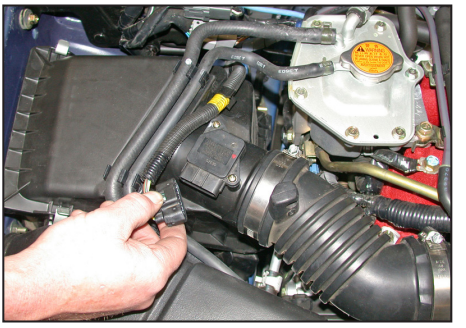

2. Disconnect the mass air sensor electrical connection as shown.

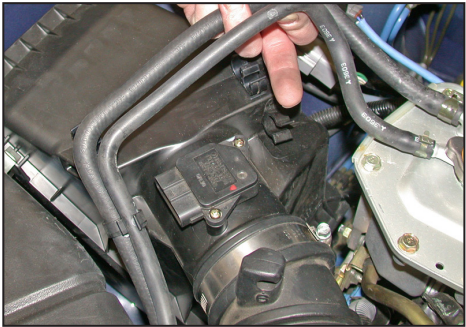

3. Unclip the coolant lines from the top of the air cleaner as shown.



4. Loosen the hose clamp as shown.

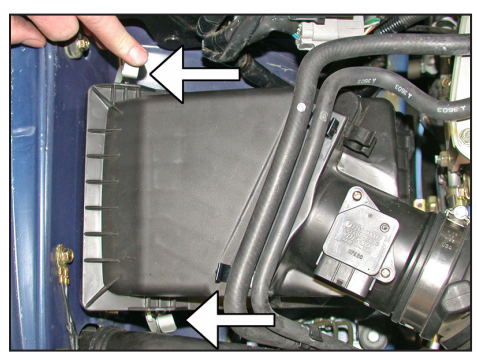

5. Unclip the upper air cleaner assembly as shown.

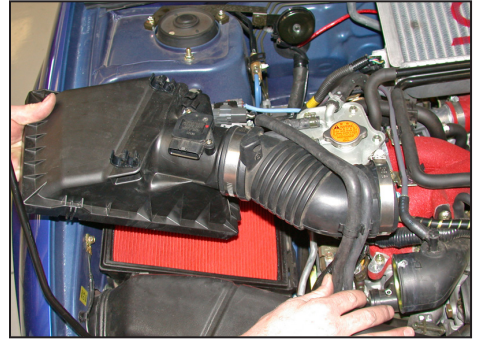

6. Remove the upper air cleaner assembly as shown.



7. Remove the mass air sensor from the upper air cleaner assembly as shown.

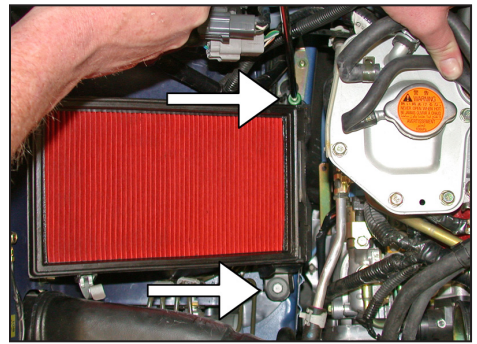

8. Remove the two bolts that secure the lower air cleaner assembly as shown.

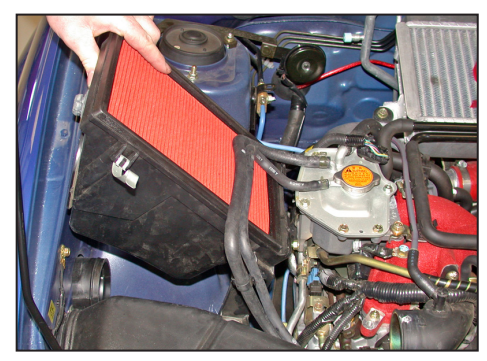

9. Remove the lower air cleaner assembly as shown.

NOTE: K&N Engineering, Inc., recommends that customers do not discard factory air intake.

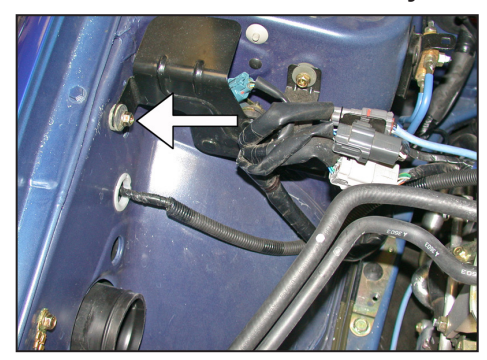

10. Remove the bolt on the wire harness bracket on the inner fender as shown.

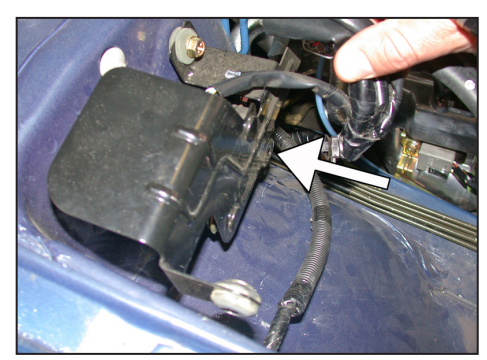

11. Unclip the wire harness from the bracket as shown.

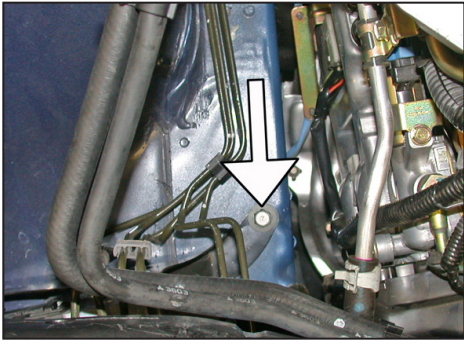

12. Install the stock air cleaner bolt into the original air cleaner mounting hole as shown.

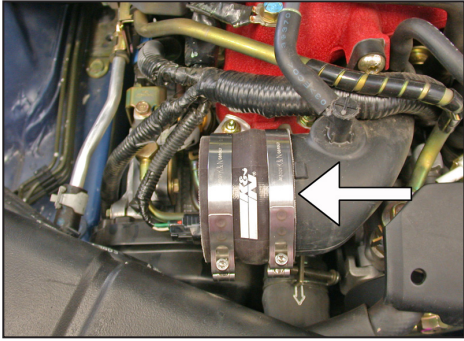

13. Install the silicone hose and hose clamps onto the plastic air inlet duct.

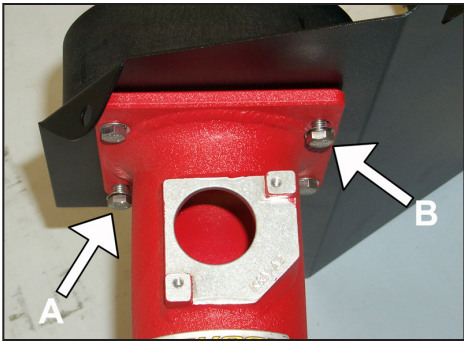

14. Assemble the intake tube, gaskets, heat shield, and filter adapter using the provided hardware as shown.

NOTE: Install the lower bolt, (arrow A) and the upper bolt, (arrow B) loose as shown.

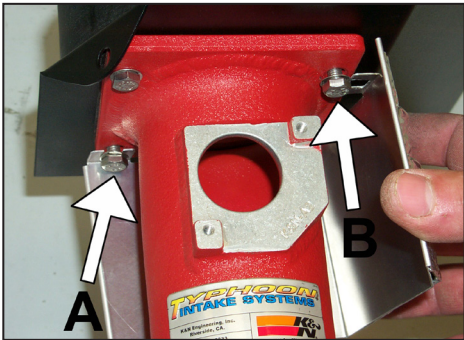

15. Install the heat insulation plate on the intake tube flange and secure it to the bolts "A" and "B" as shown.



16. Install the provided edge trim onto the heat shield and trim as shown.

NOTE: Some trimming of the edge trim may be necessary.

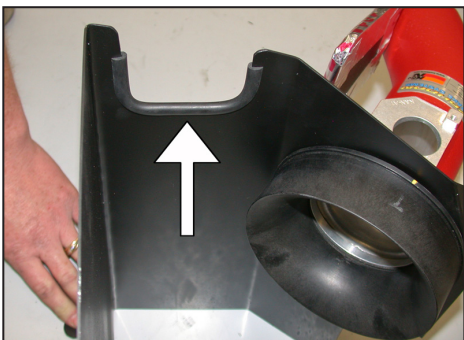

17. Install the small edge trim onto the heat shield as shown.

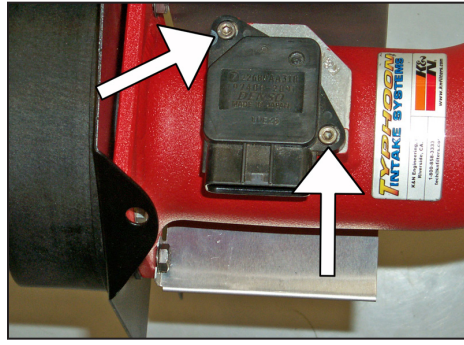

18. Install the mass air sensor from step 7 into the K&N® intake tube and secure with the provided hardware as shown.

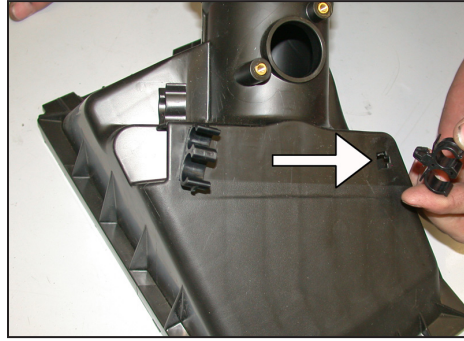

19. Remove one of the hose clips from the stock airbox assembly as shown.

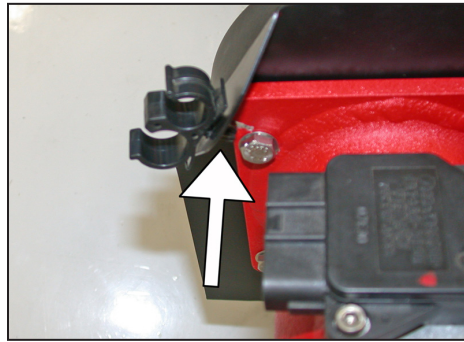

20. Install the hose clip from step 19 onto the heat shield as shown.

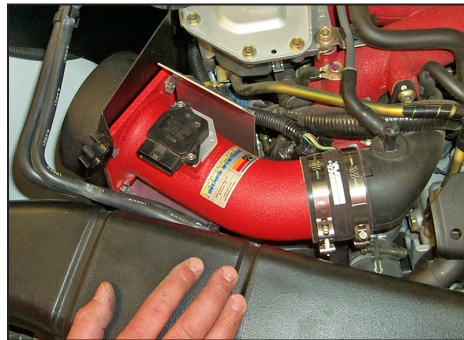

21. Install the complete assembly into the vehicle and slide the tube into the silicone hose as shown.



22. Remove the coolant hose clip as shown.

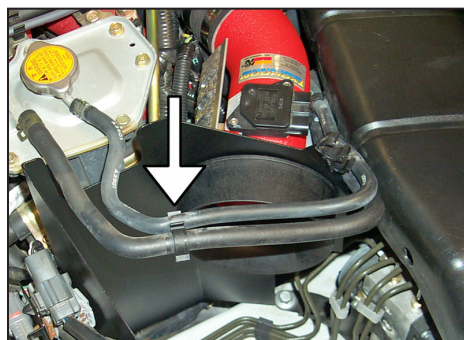

23. Reinstall the hose clip from step 22 and locate as shown.

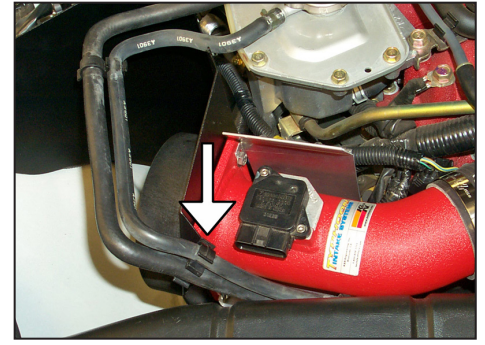

24. Secure the coolant hoses to the hose clip on the heatshield as shown.

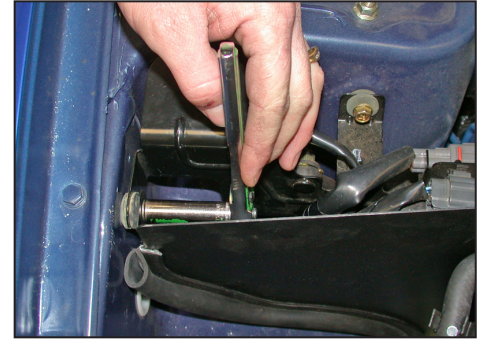

25. Using the bolt removed in step 10, secure the heat shield to the inner fender bracket but do not tighten at this time.

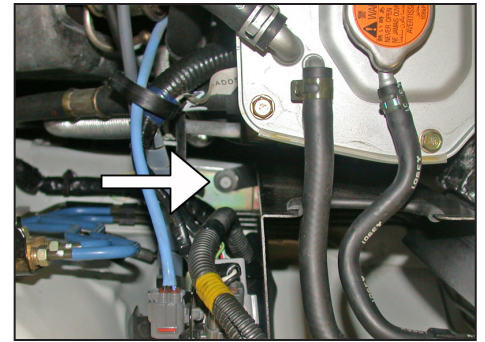

26. Use the remaining stock air cleaner hex bolt to secure the heat shield as shown.



27. Tighten the hose clamp at the silicone hose as shown.



28. Install the remaining trim seal onto the heat shield and trim to fit as shown.
NOTE: Some trimming of the edge trim may be necessary.



29. Install the K&N® air filter and and secure with the provided hose clamp as shown.

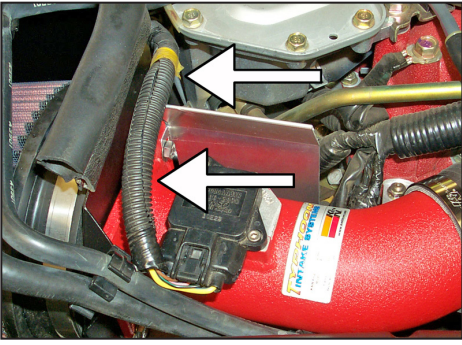

30. Route the mass air sensor electrical connection under the coolant lines and between the heat shield and insulation plate and reconnect the mass air sensor electrical connection as shown.

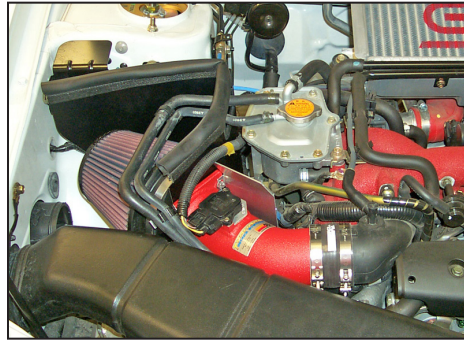

31. Reconnect the vehicle's negative battery cable. Double check to make sure everything is tight and properly positioned before starting the vehicle.

32. The C.A.R.B. exemption sticker, (attached), must be visible under the hood so that an emissions inspector can see it when the vehicle is required to be tested for emissions. California requires testing every two years, other states may vary.

33. It will be necessary for all K&N® high flow intake systems to be checked periodically for realignment, clearance and tightening of all connections. Failure to follow the above instructions or proper maintenance may void warranty.

ROAD TESTING:

1. Start the engine with the transmission in neutral or park, and the parking brake engaged. Listen for air leaks or odd noises. For air leaks secure hoses and connections. For odd noises, find cause and repair before proceeding. This kit will function identically to the factory system except for being louder and much more responsive.

2. Test drive the vehicle. Listen for odd noises or rattles and fix as necessary.

3. If road test is fine, you can now enjoy the added power and performance from your kit.

4. K&N Engineering, Inc., suggests checking the air filter element periodically for excessive dirt build-up. When the element becomes covered in dirt (or once a year), service it according to the instructions on the Recharger® service kit, part number 99-5050 or 99-5000.

INTAKE SYSTEMS FOR VEHICLES LISTED ARE 50 STATE LEGAL. SEE KNFILTERS.COM FOR CARB STATUS ON EACH PART FOR A SPECIFIC VEHICLE.