



TYPHOON INTAKE SYSTEMS

INTAKE SYSTEMS FOR VEHICLES LISTED ARE 50 STATE LEGAL. SEE KNFILTERS.COM FOR CARB STATUS ON EACH PART FOR A SPECIFIC VEHICLE.

INSTALLATION INSTRUCTIONS

69-7079TS

NISSAN

2013-14 Juke / Juke NISMO

L4-1.6L Turbo

TOOLS NEEDED:

- flat blade screw driver
- phillips screw driver
- ratchet
- extension
- 13mm socket
- 10mm socket
- pliers
- 3mm allen key

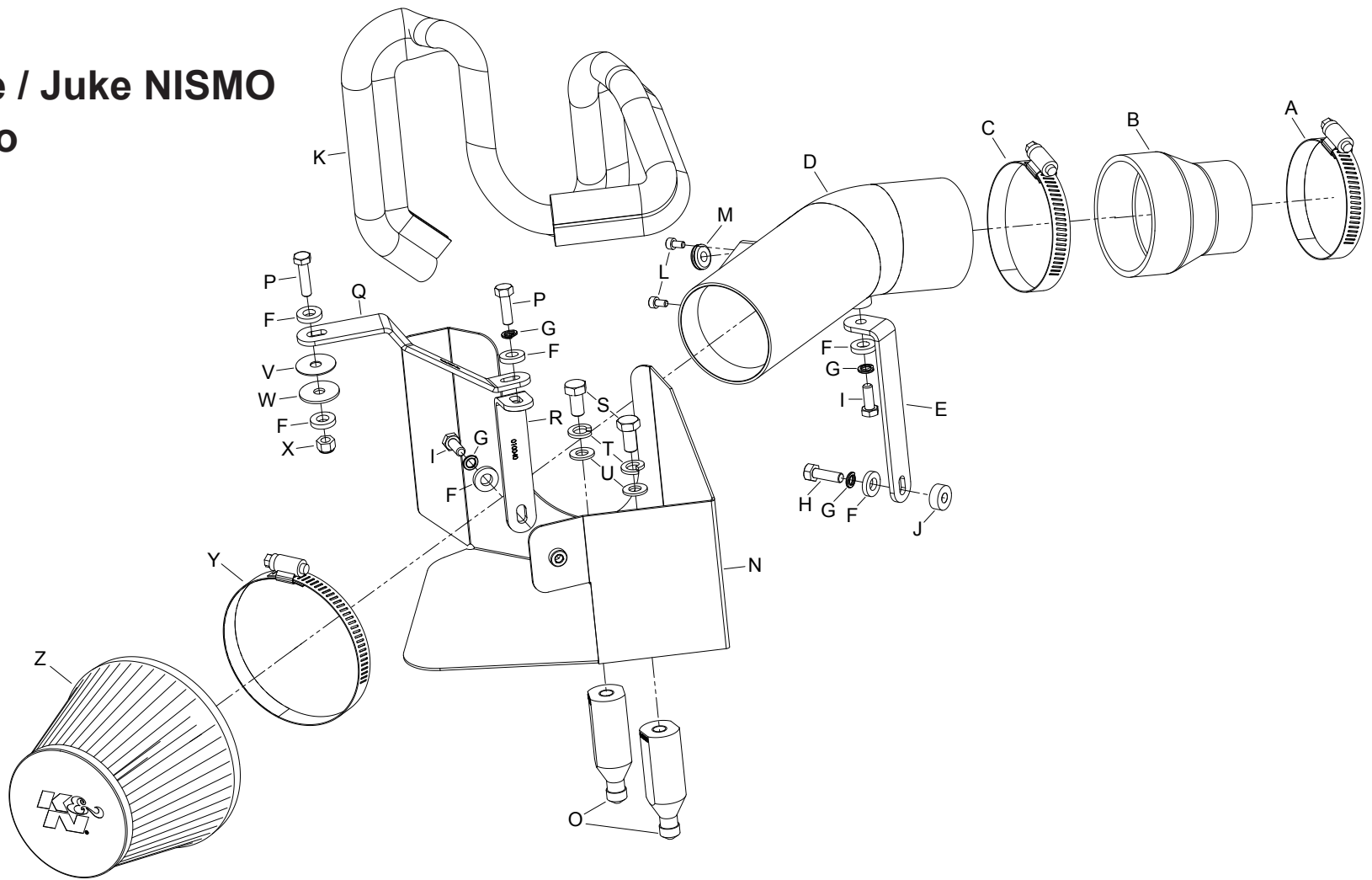

PARTS LIST:

Description	Qty.	Part #	Description	Qty.	Part #	Description	Qty.	Part #
A Hose Clamp #40	1	08554	J Spacer; .625"OD X .250"ID	1	06555	S Bolt; 8MM-1.25 X 16MM	2	07844
B Hose; 2-3/4" To 2"ID X 3"L TPRD	1	5-1045	K Edge Trim	1	102489	T Washer; M8 Split Lock Zinc	2	1-3036
C Hose Clamp #44 Stainless	1	08560	L Bolt; M4-0.07 8MM, A/H Cap, SS	2	07733	U Washer; M8 Flat Washer	2	08272
D Intake Tube	1	27612TS	M Grommet; 5/8"OD, 1/4"ID	1	08061	V Washer; 1"D X 1/4 Hole Fender	1	08160
E Bracket; "L", 63-1566, STL	1	083164	N Heast Shield	1	073153	W Washer; 1" X .300 X .100 Rubber	1	21685
F Washer; 1/4"ID X 5/8"OD -SAE	6	08275	O Standoff; 6.0 Ford Airbox	2	06532	X Nut; 6MM Nylock, Hexhead, SS	1	07512
G Washer; M+ Split Lock Zinc	4	1-3025	P Bolt; M6 X 1.00" X 20MM Hex	2	07795	Y Hose Clamp #48	1	08601
H Bolt; M6-1.00 X 25MM, SS	1	07858	Q Bracket; "Z", 69-7003, STL	1	064315	Z Air Filer	1	RC-5128
I Bolt; 6MM-1.00 X 16MM, SS	2	07812	R Bracket; 69-8605, "L" Short, STL	1	010040			

NOTE: FAILURE TO FOLLOW INSTALLATION INSTRUCTIONS AND NOT USING THE PROVIDED HARDWARE MAY DAMAGE THE INTAKE TUBE, THROTTLE BODY AND ENGINE.

TO START:

1. Turn off the ignition and disconnect the negative battery cable.
NOTE: Disconnecting the negative battery cable erases pre-programmed electronic memories. Write down all memory settings before disconnecting the negative battery cable. Some radios will require an anti-theft code to be entered after the battery is reconnected. The anti-theft code is typically supplied with your owner's manual. In the event your vehicles anti-theft code cannot be recovered, contact an authorized dealership to obtain your vehicles anti-theft code.



2. Disconnect the mass air sensor electrical connection and unhook the wiring harness from the air box.

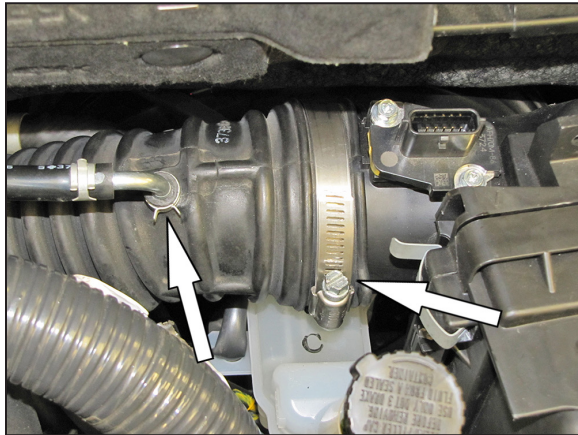

3. Loosen the hose clamp securing the intake hose to the air box and then release the spring clamp securing the turbo waste gate vent line to the intake tube.



4. Pull up and release the fresh air intake tube and then remove the fresh air intake tube from the vehicle.

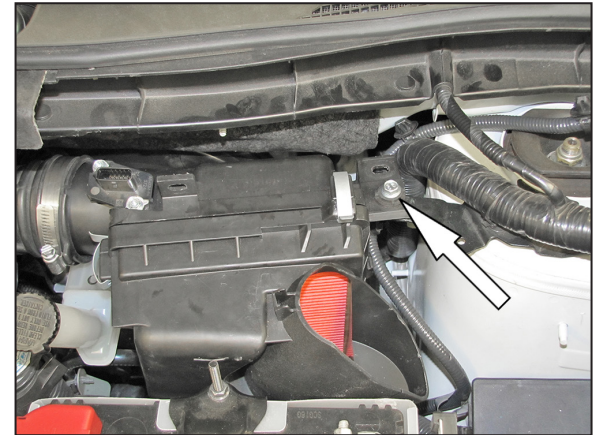

5. Remove the bolt securing the air box to the inner fender.

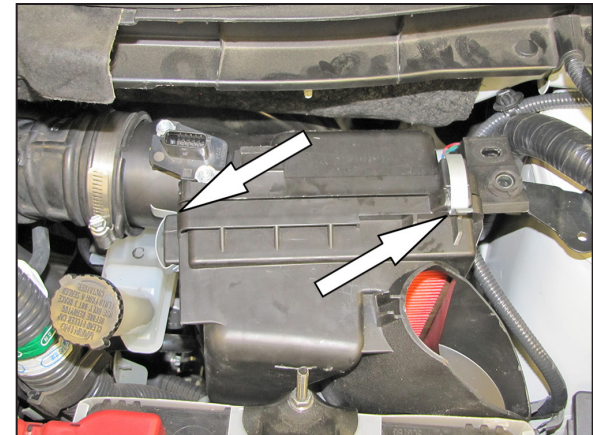

6. Release the two air box retaining clips and then remove the front half of the air box housing from the vehicle.



7. Lift up the rear air box housing and remove it from the vehicle.

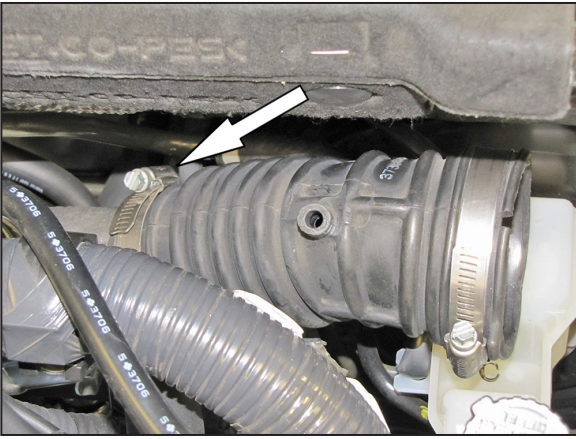

8. Loosen the hose clamp securing the intake hose to the turbo inlet and then remove the intake hose from the vehicle.

NOTE: K&N Engineering, Inc., recommends that customers do not discard factory air intake.

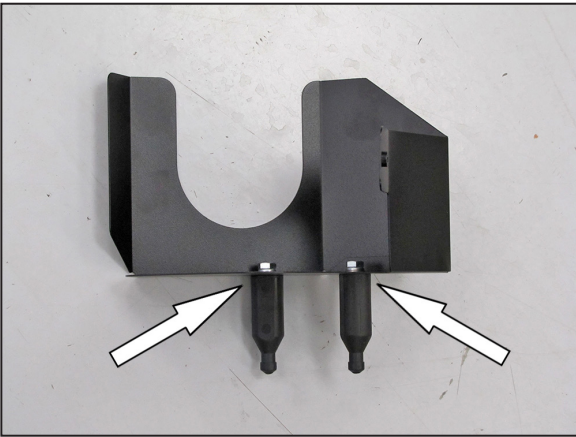

9. Attach the two stand-offs to the bottom of the K&N® heat shield as shown and secure with the hardware provided.

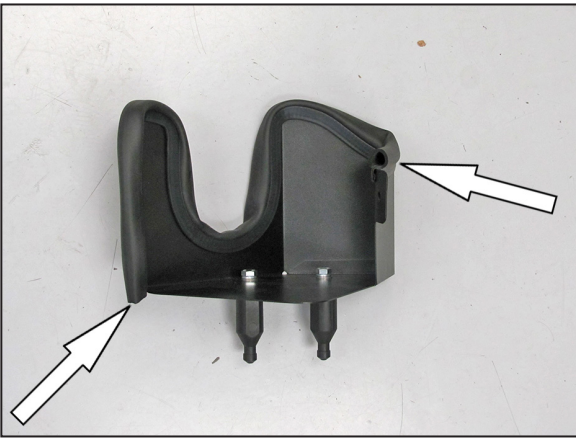

10. Install the provided edge trim onto the heat shield as shown.

NOTE: Some trimming of the edge trim will be necessary.

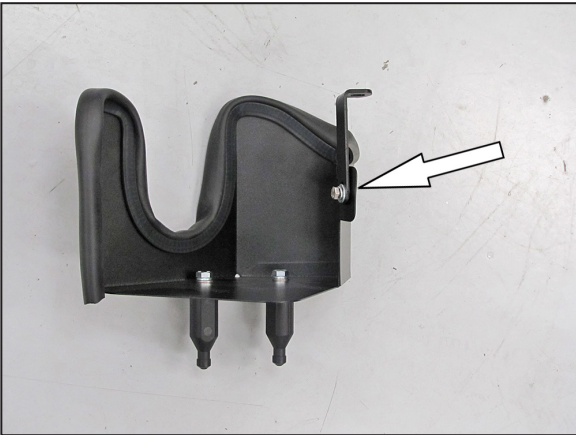

11. Install the mounting bracket (010040) onto the heat shield as shown using the provided hardware. **NOTE: Do not completely tighten at this time.**



12. Install the heat shield into position on the air box mounting grommets as shown.

NOTE: Do not secure the bracket at this time.



13. Install the coupling hose (5-1045) to the turbo inlet and secure with the provided hose clamp.

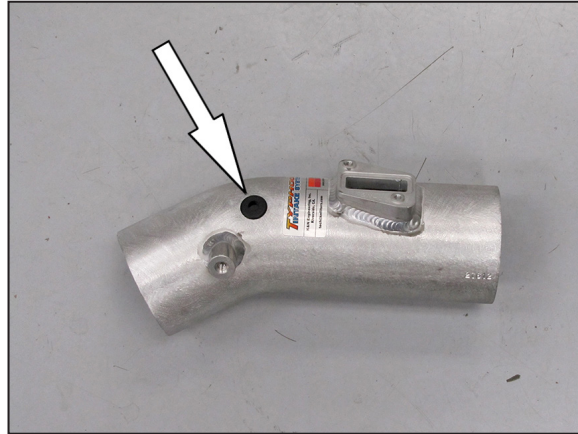

14. Install the provided grommet into the K&N® intake tube as shown.

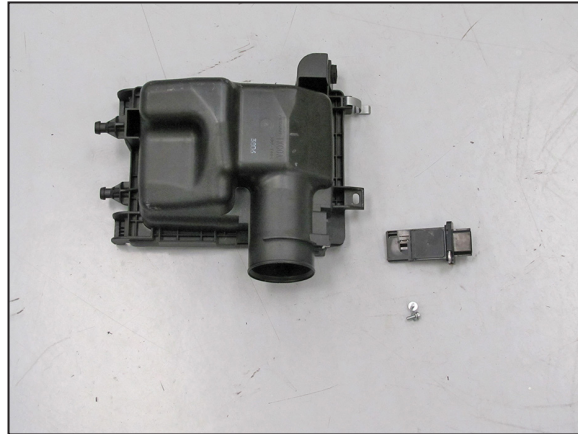

15. Remove the mass air sensor from the factory air box.



16. Install the mass air sensor into the K&N® intake tube and secure with the provided hardware.

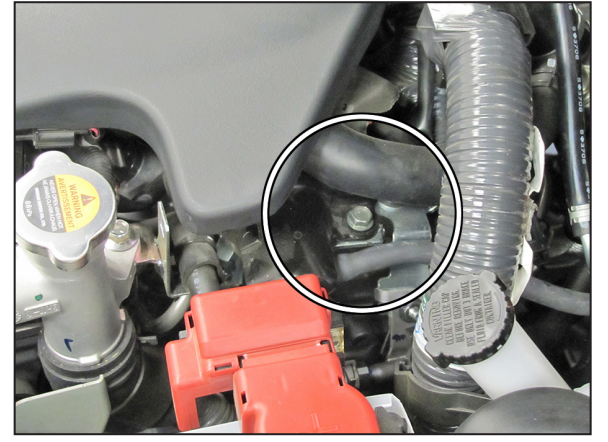

17. Remove the 6mm cover bolt shown.

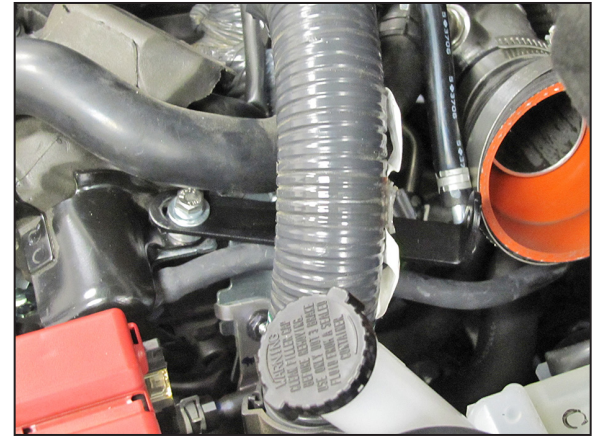

18. Install the tube mounting bracket (083164) onto the location from step #17 and secure with the provided hardware.

NOTE: Be sure to place the provided spacer under the bracket.

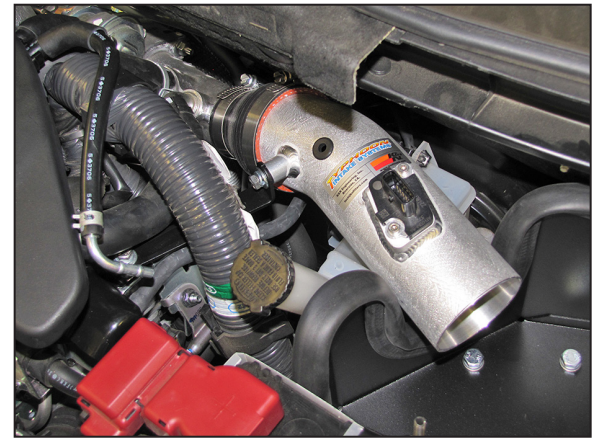

19. Install the K&N® intake tube into the coupling hose at the turbo inlet and align with the mounting bracket. Then secure the intake tube with the provided hardware and hose clamp.



20. Insert the turbo waste gate fitting into the grommet installed into the K&N® intake tube. Use care so that the grommet is not pushed through the hole into the intake tube.

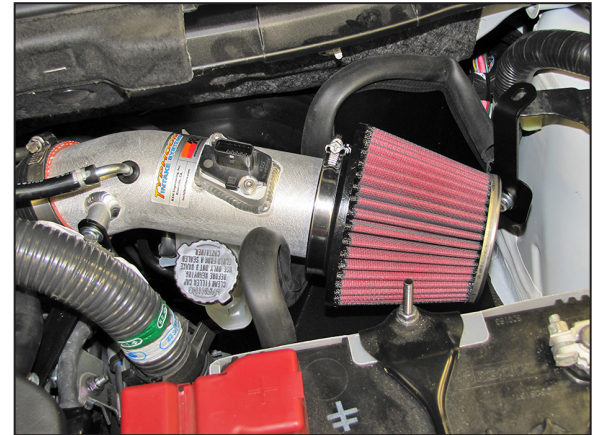

21. Install the K&N® air filter onto the intake tube and secure with the provided hose clamp.



22. Route the mass air sensor wiring harness around the rear of the heat shield and then connect the mass air sensor electrical connection.

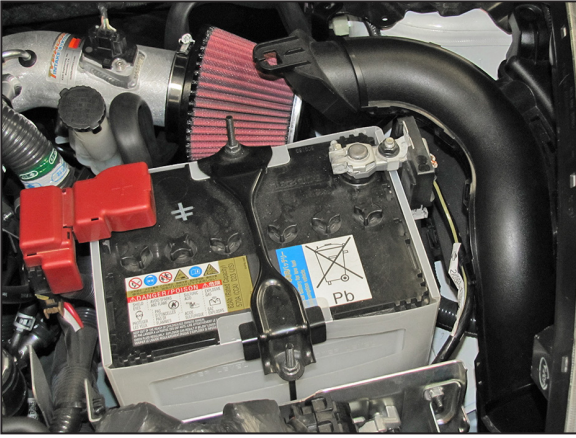

23. Reinstall the fresh air intake tube as shown.

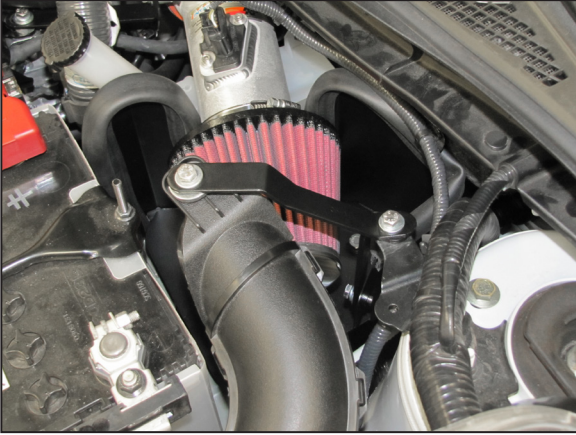

24. Secure the fresh air intake tube with the provided bracket (064315) and hardware on top of the heat shield mounting bracket.

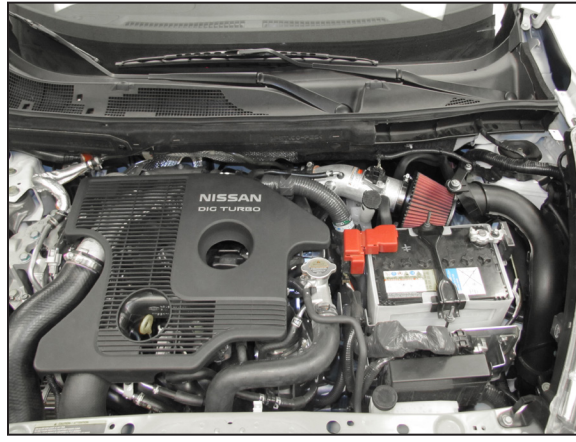

25. Reconnect the vehicle's negative battery cable. Double check to make sure everything is tight and properly positioned before starting the vehicle.

26. The C.A.R.B. exemption sticker, (attached), must be visible under the hood so that an emissions inspector can see it when the vehicle is required to be tested for emissions. California requires testing every two years, other states may vary.

27. It will be necessary for all K&N® high flow intake systems to be checked periodically for realignment, clearance and tightening of all connections. Failure to follow the above instructions or proper maintenance may void warranty.

ROAD TESTING:

1. Start the engine with the transmission in neutral or park, and the parking brake engaged. Listen for air leaks or odd noises. For air leaks secure hoses and connections. For odd noises, find cause and repair before proceeding. This kit will function identically to the factory system except for being louder and much more responsive.

2. Test drive the vehicle. Listen for odd noises or rattles and fix as necessary.

3. If road test is fine, you can now enjoy the added power and performance from your kit.

4. K&N Engineering, Inc., requires cleaning the intake system's air filter element every 100,000 miles. When used in dusty or off-road environments, our filters will require cleaning more often. We recommend that you visually inspect your filter once every 25,000 miles to determine if the screen is still visible. When the screen is no longer visible some place on the filter element, it is time to clean it. To clean and re-oil, purchase our filter Recharger® service kit, part number 99-5050 or 99-5000 and follow the easy instructions.

INTAKE SYSTEMS FOR VEHICLES LISTED ARE 50 STATE LEGAL. SEE KNFILTERS.COM FOR CARB STATUS ON EACH PART FOR A SPECIFIC VEHICLE.