



TYPHOON INTAKE SYSTEMS

NOT LEGAL FOR SALE OR USE ON ANY POLLUTION CONTROLLED MOTOR VEHICLE IN CALIFORNIA OR STATES ADOPTING CALIFORNIA EMISSION PROCEDURES.

See knfilters.com for CARB status on each part for a specific vehicle

INSTALLATION INSTRUCTIONS

**69-2024TTK
MINI
2012-14 Cooper
L4-1.6L**

TOOLS NEEDED:

- Ratchet
- Extension
- 10mm socket
- T27 torx
- T25 torx
- Flat Blade Screw Driver

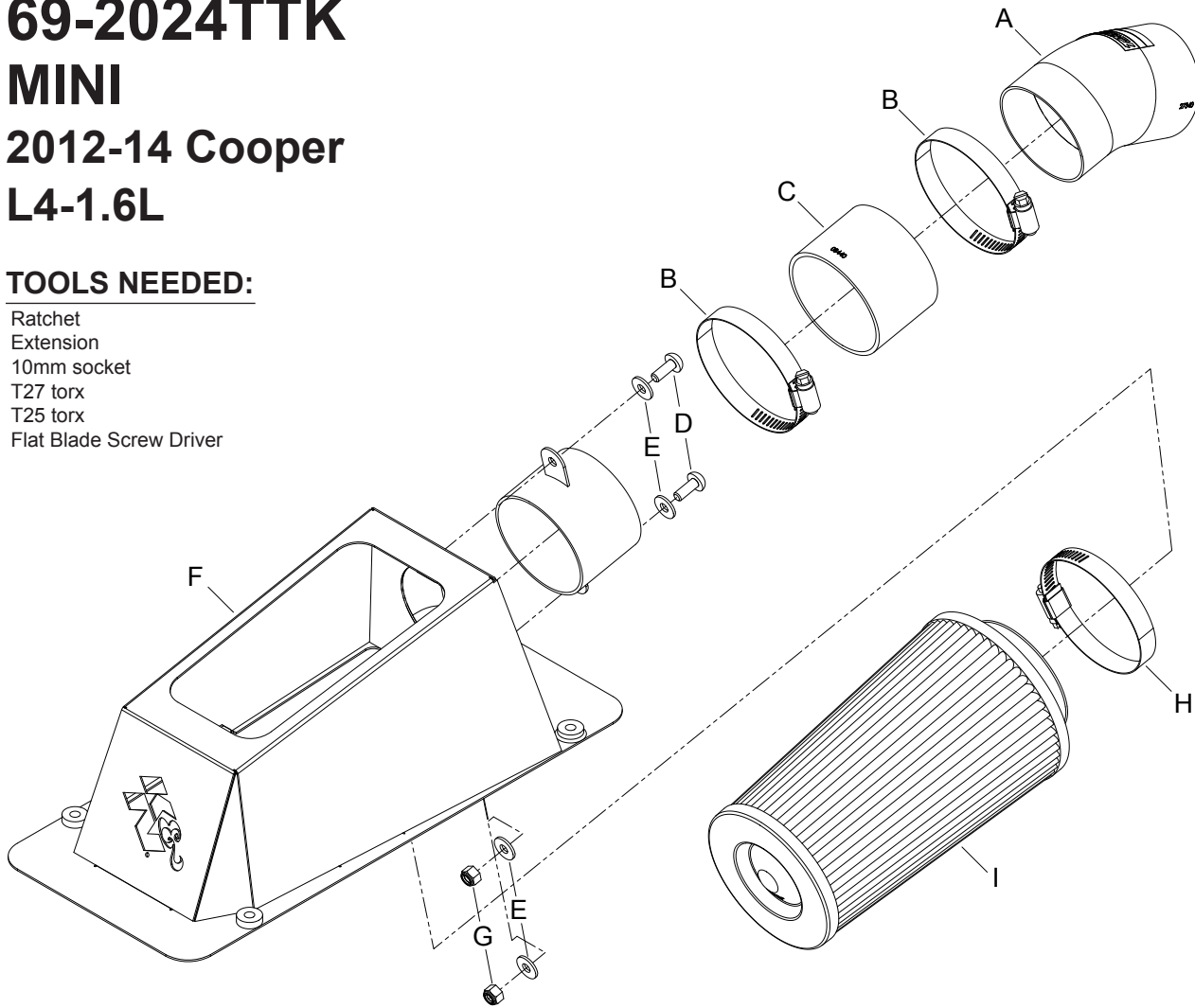

PARTS LIST:

Description	Qty.	Part #
A Intake Tube	1	27340TK
B Hose Clamp #44 Stainless	2	08560
C Hose; 2-3/4" ID X 2" L Reinforced	1	08440
D Bolt; M6 X 1.00 X 16MM	2	07730
E Washer; 6MM, Flat, SS	4	08269
F Heat Shield	1	074066
G Nut; 6MM Nylock, Hexhead, SS	2	07512
H Hose Clamp #44	1	08577
I Air Filter	1	RC-5144

NOTE: FAILURE TO FOLLOW INSTALLATION INSTRUCTIONS AND NOT USING THE PROVIDED HARDWARE MAY DAMAGE THE INTAKE TUBE, THROTTLE BODY AND ENGINE.

TO START:

1. Turn off the ignition and disconnect the negative battery cable.
NOTE: Disconnecting the negative battery cable erases pre-programmed electronic memories. Write down all memory settings before disconnecting the negative battery cable. Some radios will require an anti-theft code to be entered after the battery is reconnected. The anti-theft code is typically supplied with your owner's manual. In the event your vehicles anti-theft code cannot be recovered, contact an authorized dealership to obtain your vehicles anti-theft code.

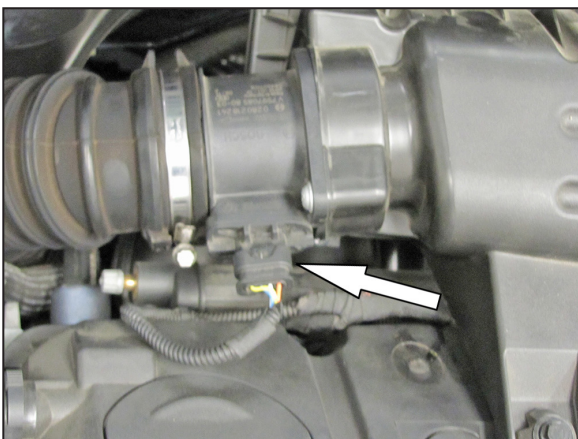

2. Disconnect the mass air sensor electrical connection.

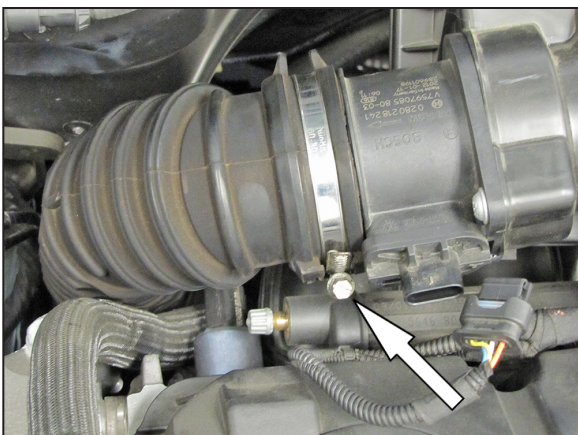

3. Loosen the hose clamp that secures the intake hose to the mass air sensor.



4. Disconnect the intake hose from the mass air sensor.

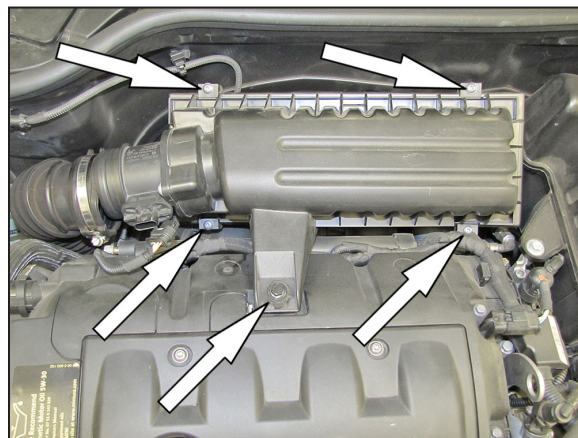

5. Loosen the one bolt and four screws that secure the upper air filter housing.

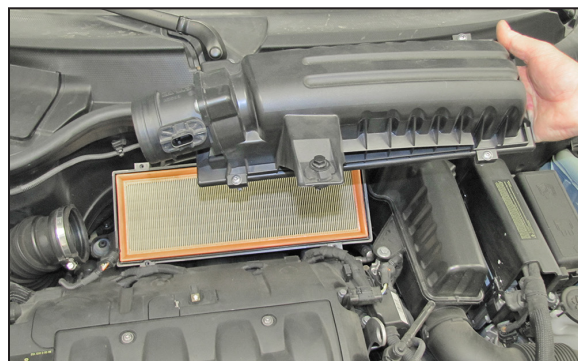

6. Remove the upper air filter housing and air filter. **NOTE: K&N Engineering, Inc., recommends that customers do not discard factory air intake.**

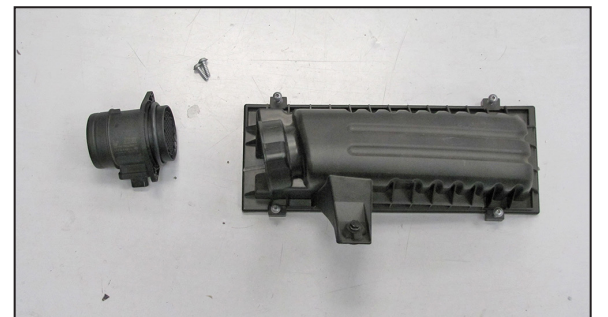

7. Remove the two bolts that secure the mass air sensor to the upper housing and then remove the mass air sensor.



8. Remove the O-ring from the mass air sensor and then install the mass air sensor to the K&N® heat shield and secure with the provided hardware.

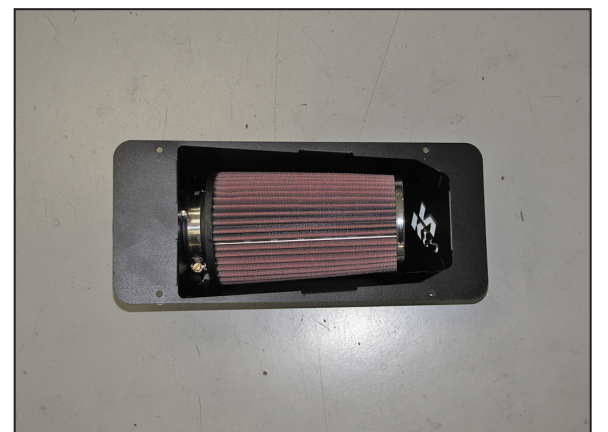

9. Install the K&N® air filter onto the mass air sensor and secure with the provided hose clamp.

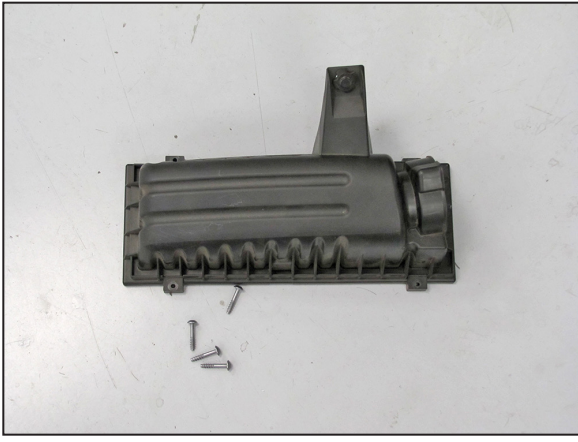

10. Remove the four upper housing mounting screws.

NOTE: The screws should be unthreaded from the housing.



11. Install the K&N® filter assembly onto the lower air filter housing and secure with the factory screws from step #10.

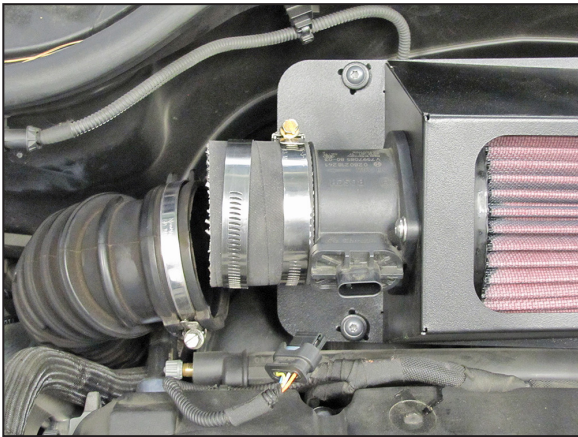

12. Install the silicone hose (08440) onto the throttle body and secure with the provided hose clamp.



13. Install the K&N® intake tube into the factory hose and then into the hose at the throttle body, then secure with the factory and provided hose clamps.

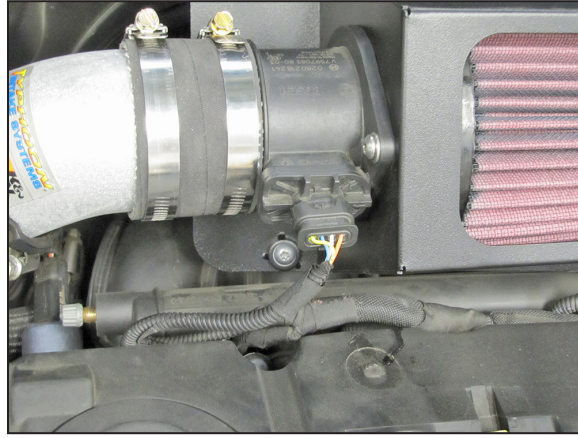

14. Reconnect the mass air sensor electrical connection.

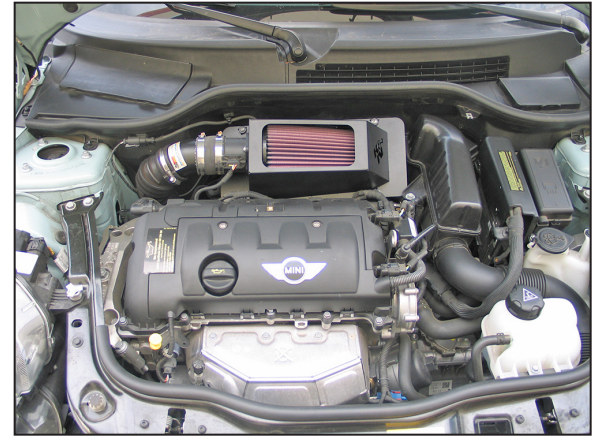

15. Reconnect the vehicle's negative battery cable. Double check to make sure everything is tight and properly positioned before starting the vehicle.

16. It will be necessary for all K&N® high flow intake systems to be checked periodically for realignment, clearance and tightening of all connections. Failure to follow the above instructions or proper maintenance may void warranty.

ROAD TESTING:

1. Start the engine with the transmission in neutral or park, and the parking brake engaged. Listen for air leaks or odd noises. For air leaks secure hoses and connections. For odd noises, find cause and repair before proceeding. This kit will function identically to the factory system except for being louder and much more responsive.

2. Test drive the vehicle. Listen for odd noises or rattles and fix as necessary.

3. If road test is fine, you can now enjoy the added power and performance from your kit.

4. K&N Engineering, Inc., requires cleaning the intake system's air filter element every 100,000 miles. When used in dusty or off-road environments, our filters will require cleaning more often. We recommend that you visually inspect your filter once every 25,000 miles to determine if the screen is still visible. When the screen is no longer visible some place on the filter element, it is time to clean it. To clean and re-oil, purchase our filter Recharger® service kit, part number 99-5050 or 99-5000 and follow the easy instructions.

NOT LEGAL FOR SALE OR USE ON ANY POLLUTION CONTROLLED MOTOR VEHICLE IN CALIFORNIA OR STATES ADOPTING CALIFORNIA EMISSION PROCEDURES.

See knfilters.com for CARB status on each part for a specific vehicle