



TYPHOON INTAKE SYSTEMS

INTAKE SYSTEMS FOR VEHICLES LISTED ARE 50 STATE LEGAL. SEE KNFILTERS.COM FOR CARB STATUS ON EACH PART FOR A SPECIFIC VEHICLE.

INSTALLATION INSTRUCTIONS

69-2001TWK
69-2001TS
BMW
2001-05 M3
L6-3.2L

TOOLS NEEDED:

- Pliers
- Needle Nose Pliers
- Dikes
- Flat Blade Screwdriver
- 3mm Allen Wrench
- 5mm Allen Wrench
- Ratchet
- 6" Extension
- 10mm Socket
- 13mm Socket

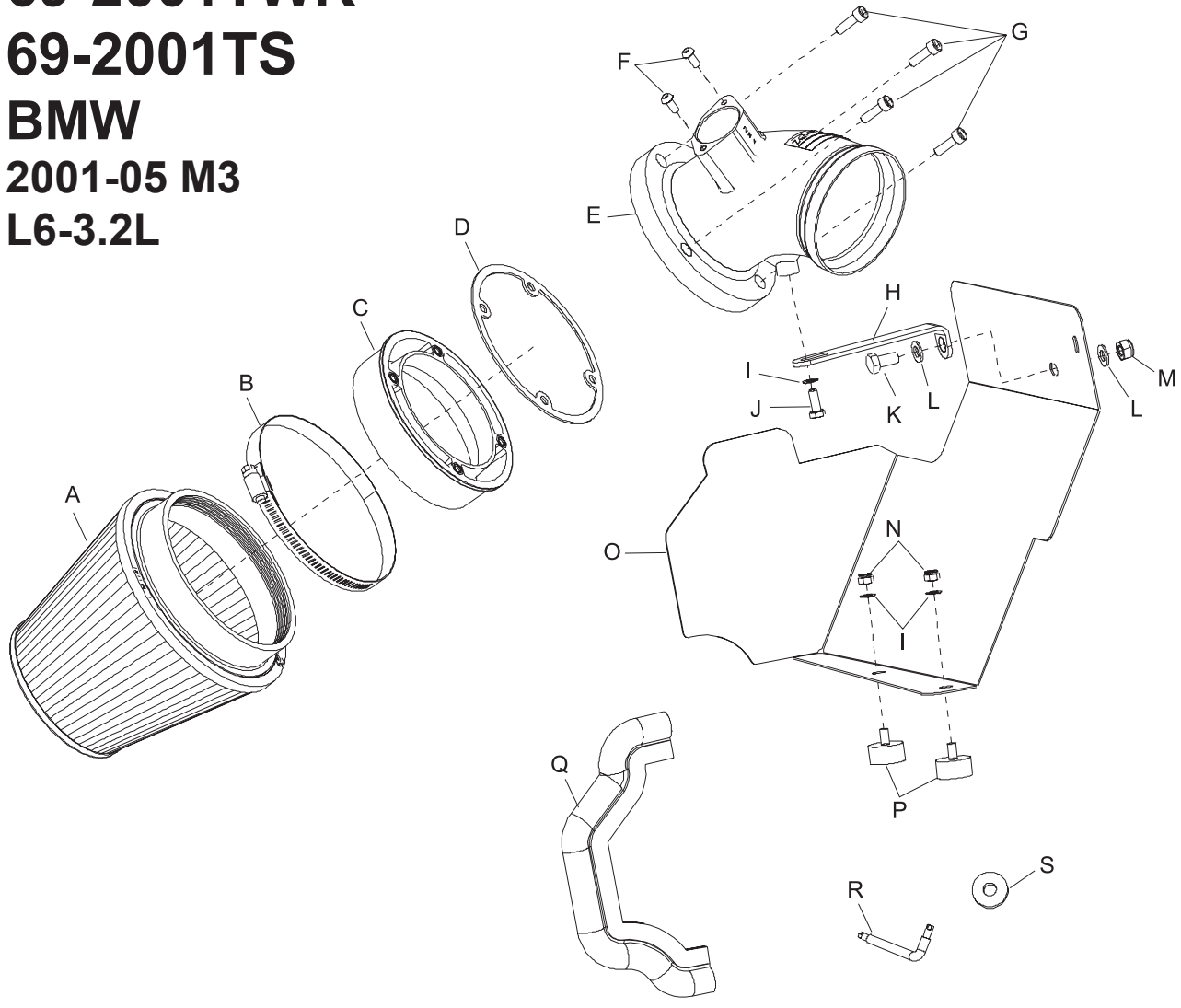

PARTS LIST:

Description	Qty.	Part #
A FILTER; 5"FLG	1	RP-5113
B HOSE CLAMP #80	1	08694
C ADAPTOR; #450	1	08839
D GASKET; 69-2001	1	09087
E INTAKE TUBE	1	27325
F BOLT; M5 - 0.8, B/H, SS	2	07734
G BOLT; 6MM X 20MM L, SHC	4	07860
H BRACKET; "L"	1	07117
I WASHER; 6MM WAVE	3	08277
J BOLT; 6MMx16MM L, HEXHEAD	1	07812
K BOLT; 8MM HEXHEAD	1	077002
L WASHER; 8MM FLAT	2	08272
M NUT; 8MM NYLOCK	1	07502
N NUT; 6MM NYLOCK	2	07512
O HEAT SHIELD; STL; FB/PC	1	07327
P STUD; MOUNT 1"T, M/F	2	02033
Q EDGE TRIM; TOP LOC, 9"L	1	102465
R WRENCH, T20 TORX	1	69801
S TEFLON SPACER	1	08281

NOTE: FAILURE TO FOLLOW INSTALLATION INSTRUCTIONS AND NOT USING THE PROVIDED HARDWARE MAY DAMAGE THE INTAKE TUBE, THROTTLE BODY AND ENGINE.

TO START:

1. Turn off the ignition and disconnect the negative battery cable.
NOTE: Disconnecting the negative battery cable erases pre-programmed electronic memories. Write down all memory settings before disconnecting the negative battery cable. Some radios will require an anti-theft code to be entered after the battery is reconnected. The anti-theft code is typically supplied with your owner's manual. In the event your vehicles' anti-theft code cannot be recovered, contact an authorized dealership to obtain your vehicles anti-theft code.

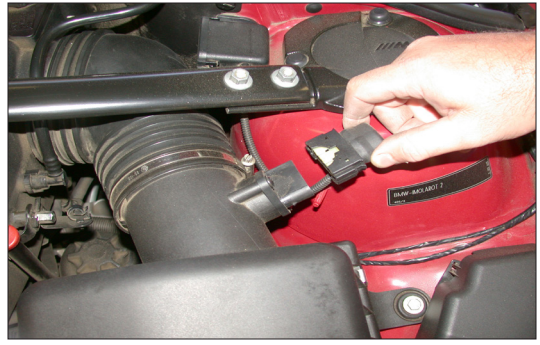

2. Disconnect the mass air sensor electrical connection as shown.



3. Unclip and remove the high intensity discharge unit cover as shown.

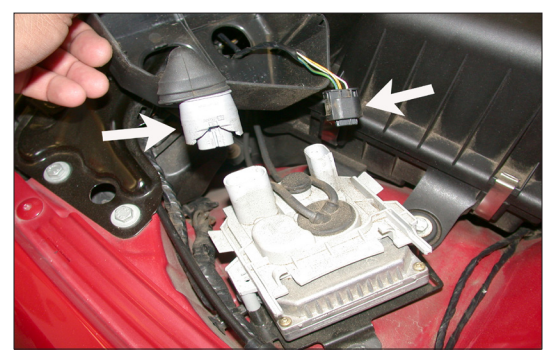

4. Unclip the two electrical connections from the high intensity discharge unit as shown.

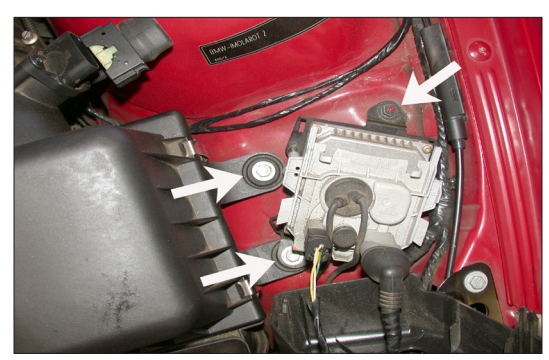

5. Loosen and remove the two bolts and one nut on the high intensity discharge unit as shown.
Note: The stock hardware will be reused in a later step.

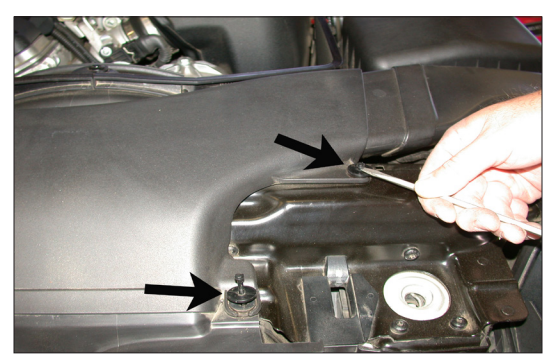

6. Remove the two plastic rivets that secure the air intake scoop as shown.

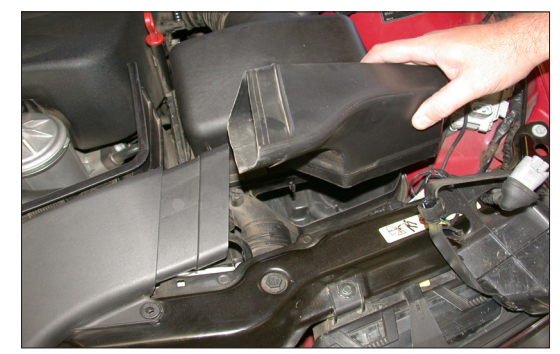

7. Remove the air cleaner air inlet duct as shown.



8. Loosen the hose clamp on the air cleaner flange as shown.

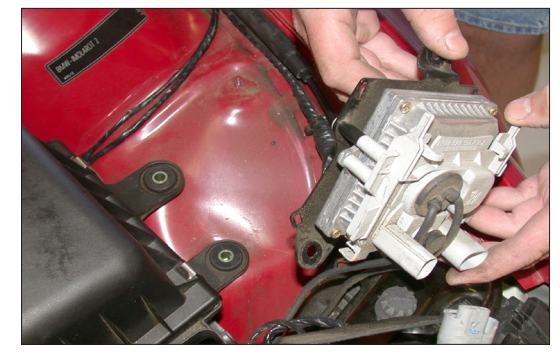

9. Lift up the high intensity discharge unit to gain access to the air cleaner.



10. Pull firmly upwards to remove the air cleaner as shown.

NOTE: K&N Engineering, Inc., recommends that customers do not discard factory air intake.



11. Remove the rubber air cleaner grommet by pulling firmly upwards.

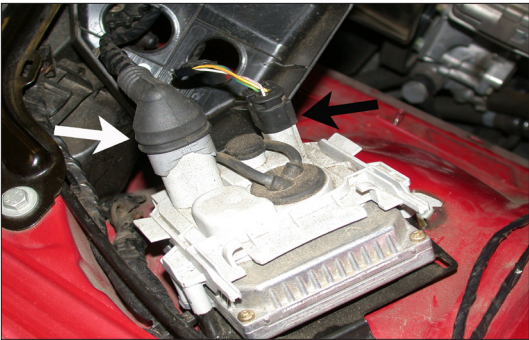

12. Reconnect the electrical connections to the high intensity discharge unit as shown.

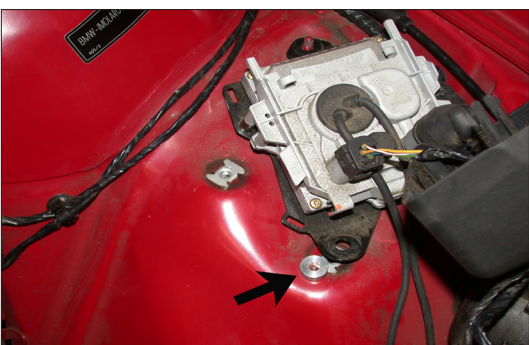

13. Place the provided spacer under the bracket of the high intensity discharge unit as shown.

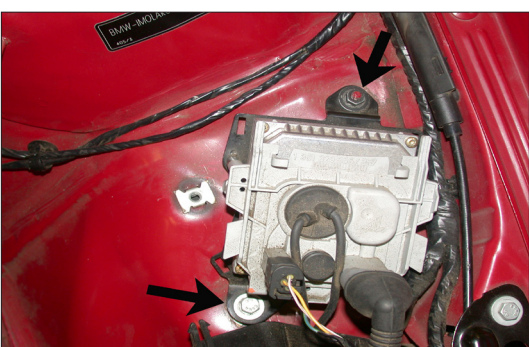

14. Secure the high intensity discharge unit using the stock hardware as shown.



15. Install the cover back onto the high intensity discharge unit as shown.



16. Remove the rubber seal from the air cleaner flange as shown.

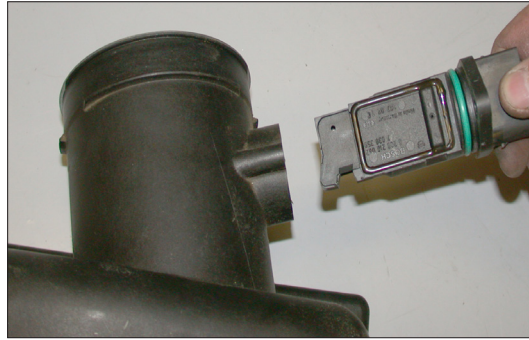

17. Using the supplied T-20 torx wrench, remove the mass air sensor from the air cleaner cover as shown.



18. Remove the velocity stack from the inside of the air cleaner cover, which is secured by two screws.



19. Disassemble the velocity stack as shown.

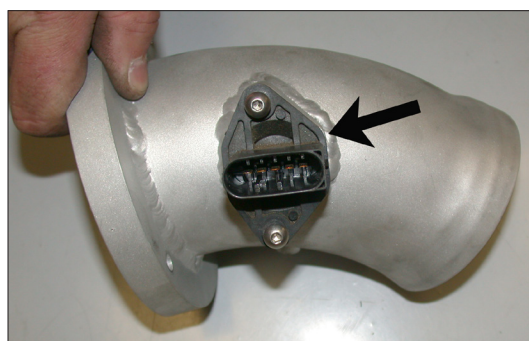

20. Install the mass air sensor from step 17 into the intake tube using the provided hardware.

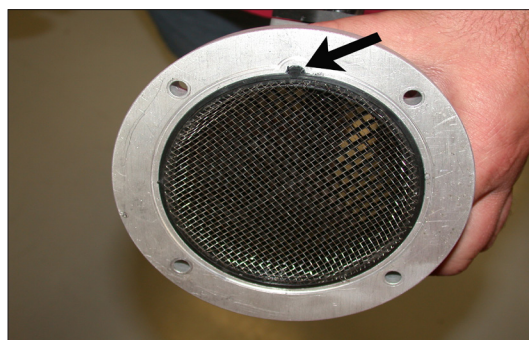

21. Install the stock mass air straightener from step 19 into the intake tube as shown.

Note: The tab on the mass air straightener should be lined up with the register on the intake tube flange.



22. Lay the provided gasket over the air filter adapter as shown.

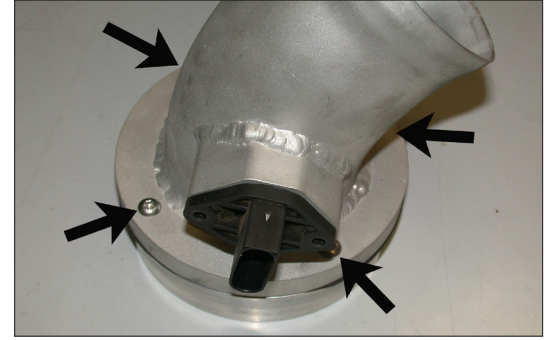

23. Assemble the intake tube and filter adapter using the provided hardware as shown.

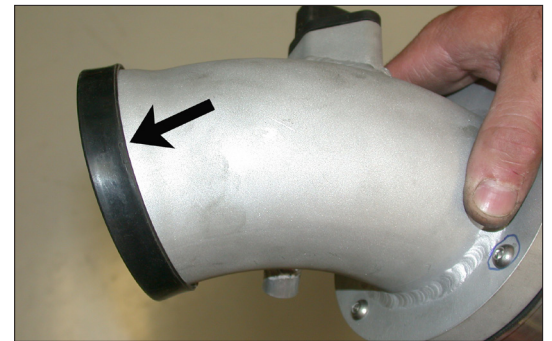

24. Place the rubber seal from step 16 onto the intake tube as shown.



25. Install the provided bracket onto the intake tube assembly using the provided hardware as shown.



26. Install the air filter onto the intake tube assembly and secure with the provided hose clamp as shown.



27. Remove the cap nut from the dipstick tube as shown.

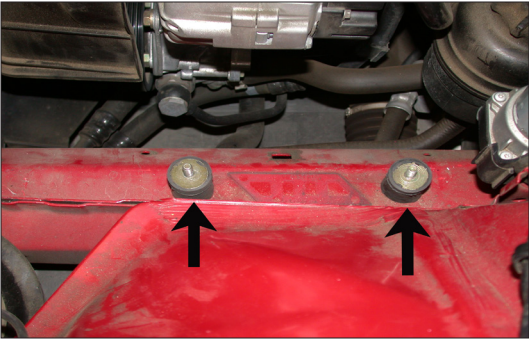

28. Install the provided rubber mounted studs onto the inner fender as shown.

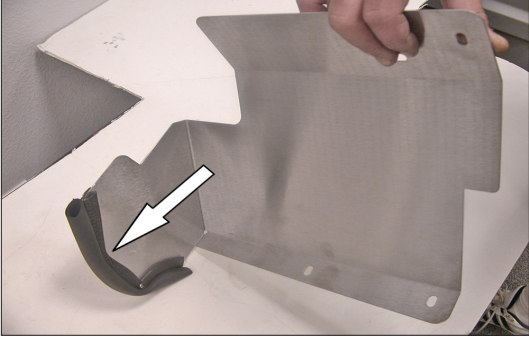

29. Install the provided edge trim onto the heat shield as shown.

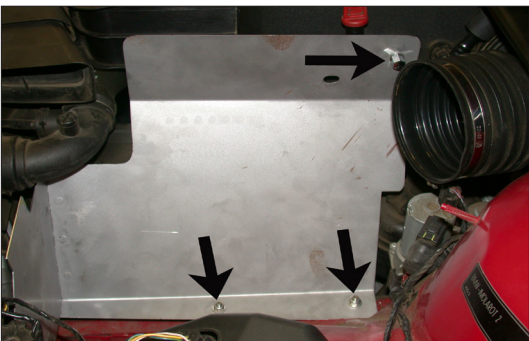

30. Install the heat shield onto the rubber mounted studs and line up the upper hole on the heat shield with the stud from the dipstick tube as shown., then, secure the heat shield with the provided hardware and stock cap nut as shown.

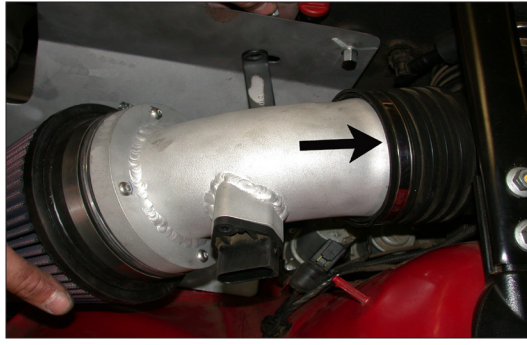

31. Slide the complete intake tube assembly into the stock intake hose as shown, but do not tighten at this time.



32. Line up the bracket with the hole on the heat shield and secure with the provided hardware as shown.

33. Adjust everything for best fit and clearance and tighten all hardware and hose clamps at this time.



34. Reconnect the mass air sensor electrical connection as shown.



35. Reconnect the vehicle's negative battery cable. Double check to make sure everything is tight and properly positioned before starting the vehicle.

36. The C.A.R.B. exemption sticker, (attached), must be visible under the hood, so the emissions inspector can see it when the vehicle is required to be tested for emissions. California requires testing every two years, other states may vary.

37. It will be necessary for all K&N® high flow intake systems to be checked periodically for realignment, clearance and tightening of all connections. Failure to follow the above instructions or proper maintenance may void warranty.

ROAD TESTING:

1. Start the engine with the transmission in neutral or park, and the parking brake engaged. Listen for air leaks or odd noises. For air leaks secure hoses and connections. For odd noises, find cause and repair before proceeding. This kit will function identically to the factory system except for being louder and much more responsive.

2. Test drive the vehicle. Listen for odd noises or rattles and fix as necessary.

3. If road test is fine, you can now enjoy the added power and performance from your kit.

4. K&N Engineering, Inc., suggests checking the air filter element periodically for excessive dirt build-up. When the element becomes covered in dirt (or once a year), service it according to the instructions on the Recharger® service kit, part number 99-5050 or 99-5000

INTAKE SYSTEMS FOR VEHICLES LISTED ARE 50 STATE LEGAL. SEE KNFILTERS.COM FOR CARB STATUS ON EACH PART FOR A SPECIFIC VEHICLE.