



TYPHOON INTAKE SYSTEMS

NOT LEGAL FOR SALE OR USE ON ANY POLLUTION CONTROLLED MOTOR VEHICLE IN CALIFORNIA OR STATES ADOPTING CALIFORNIA EMISSION PROCEDURES.
See knfilters.com for CARB status on each part for a specific vehicle

INSTALLATION INSTRUCTIONS

69-1018TS HONDA 2011-16 CR-Z L4-1.5L

TOOLS NEEDED:

Flat Blade Screwdriver
Phillips Screw Driver
Ratchet
Extension
10mm Socket
4mm Allen Wrench
3mm Allen Wrench
Pliers

PARTS LIST:

Description	Qty.	Part #
A Hose Clamp #36	2	08530
B Hose; 2-1/2" ID X 2" L Reinforced	1	08284
C Intake Tube	1	27487
D Hose; 1/2" ID X 12" L	1	087031
E Vent; 90Deg, 1/2" Hose, 1/4" NPT, Black	1	08110FK
F Bolt; M4 - 0.07 8mm, A/H Cap, SS	2	07733
G Bolt; M6 X 1.00 X 16mm, Buttonhead, SS	6	07730
H Washer, M6 Split Lock Zinc	6	1-3025
I Washer; 6mm Flat, SS	6	08269
J Bracket; "L", Sml., Stl., TB/PC	2	070066
K Bracket; Strt., Stl., TK/PC	1	083148
L Edge Trim (55")	1	102480
M Heat Shield	1	074085
N Hose Clamp #004	2	21850
O Tip; 3/8"OD X 1/4"ID X 1-1/4"L, Blk. Rubber	2	08215
P Hose; 5/16ID X 17"L	1	5-2017
Q Hose Clamp #40	1	08554
R Air Filter	1	RX-4950

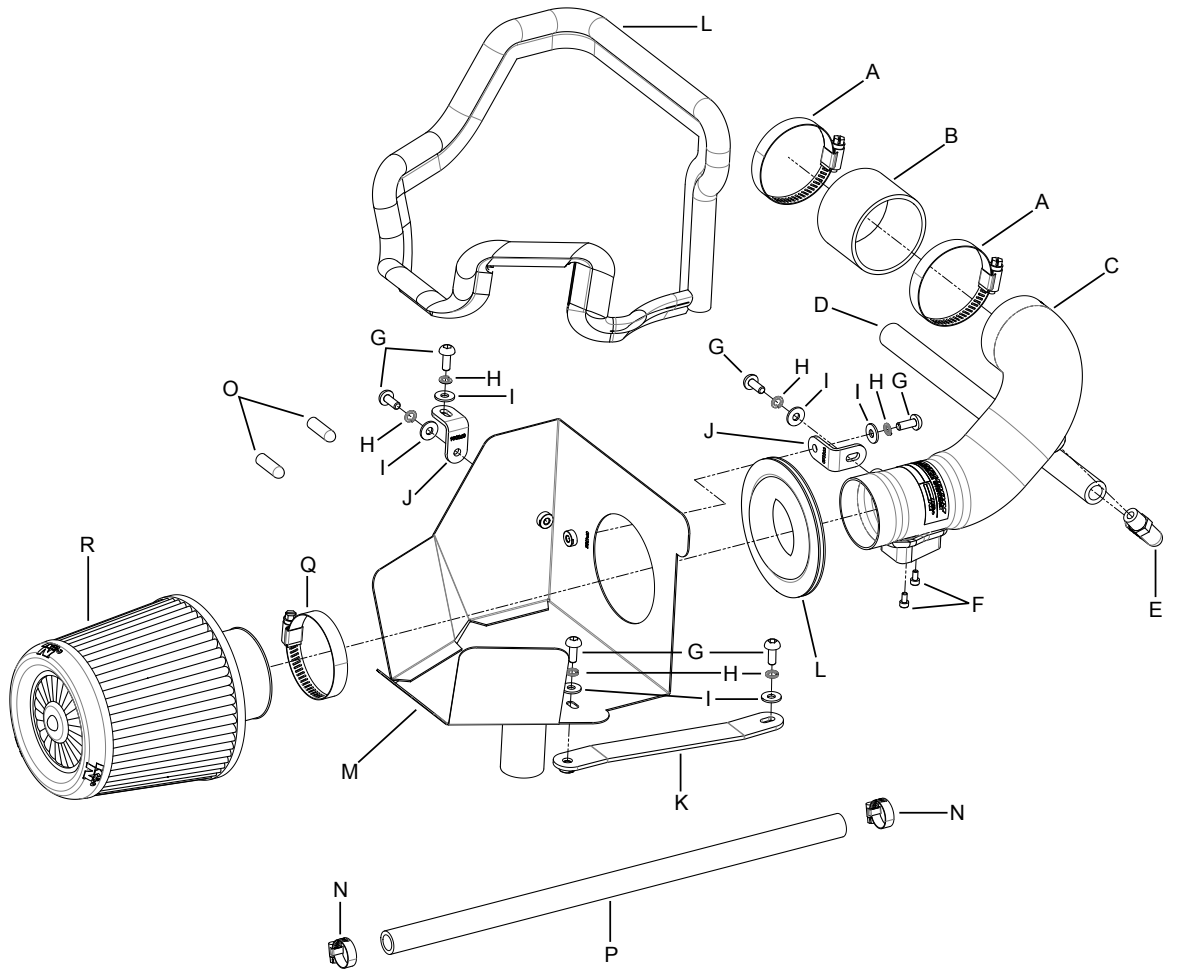

NOTE: FAILURE TO FOLLOW INSTALLATION INSTRUCTIONS AND NOT USING THE PROVIDED HARDWARE MAY DAMAGE THE INTAKE TUBE, THROTTLE BODY AND ENGINE.

TO START:

1. Turn off the ignition and disconnect the negative battery cable.

NOTE: Disconnecting the negative battery cable erases pre-programmed electronic memories. Write down all memory settings before disconnecting the negative battery cable. Some radios will require an anti-theft code to be entered after the battery is reconnected. The anti-theft code is typically supplied with your owner's manual. In the event your vehicles' anti-theft code cannot be recovered, contact an authorized dealership to obtain your vehicles anti-theft code.

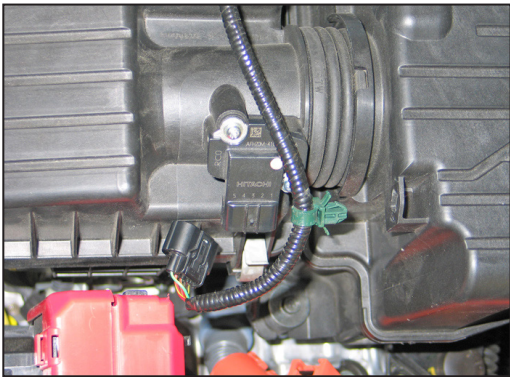

2. Disconnect the mass air sensor electrical connection and unhook the wiring harness from the airbox.

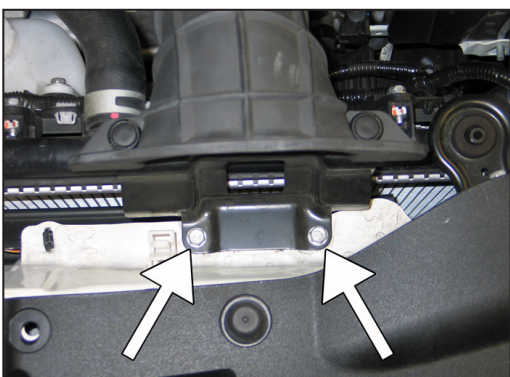

3. Remove the two bolts securing the fresh air intake scoop to the core support.

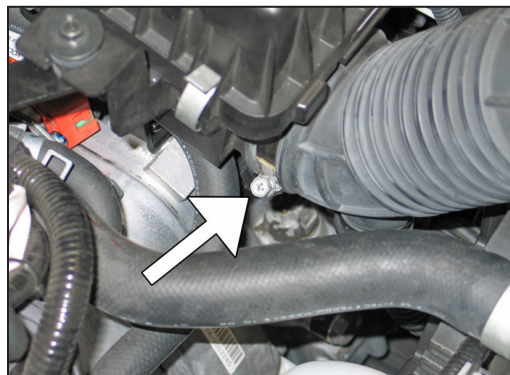

4. Loosen the hose clamp that secures the fresh air intake scoop to the airbox.

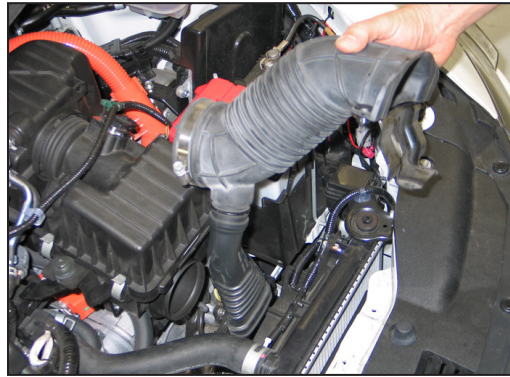

5. Remove the fresh air intake scoop from the vehicle.
NOTE: The lower fresh air duct will need to be disconnected as the fresh air intake scoop is removed.

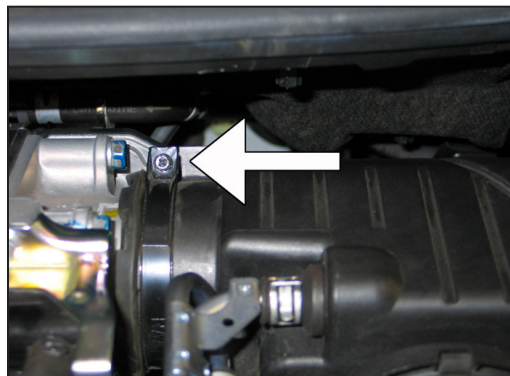

6. Loosen the hose clamp securing the intake hose to the throttle body.

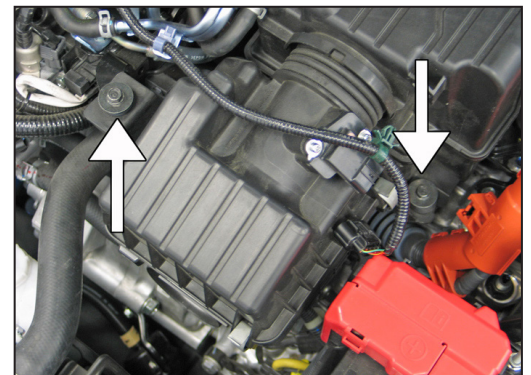

7. Remove the two bolts that secure the factory airbox.

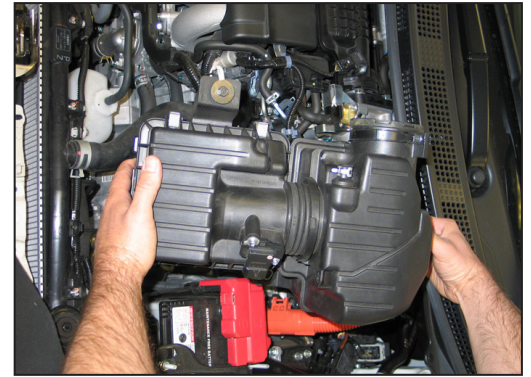

8. Remove the airbox assembly from the vehicle.
NOTE: It will be necessary to release the spring clamp securing the crankcase vent tube and hold the crankcase vent tube while removing the airbox.
NOTE: K&N Engineering, Inc., recommends that customers do not discard factory air intake.

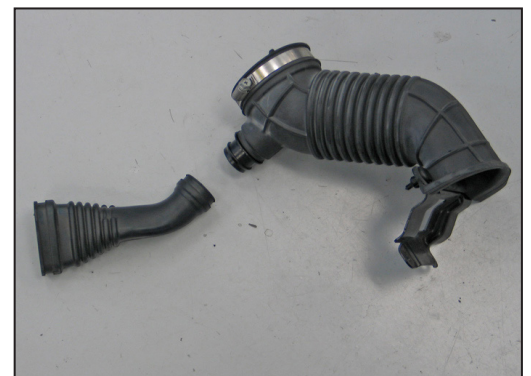

9. Separate the lower intake duct from the fresh air intake scoop.

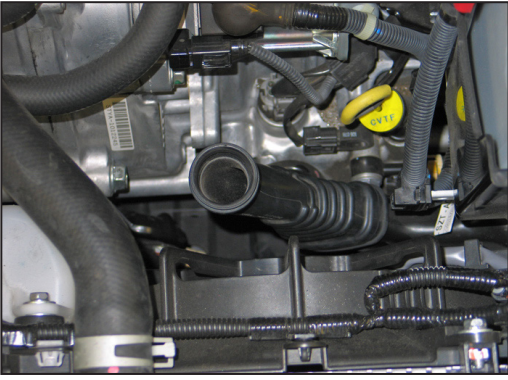

10. Reinstall the lower fresh air duct onto the factory plastic duct as shown.

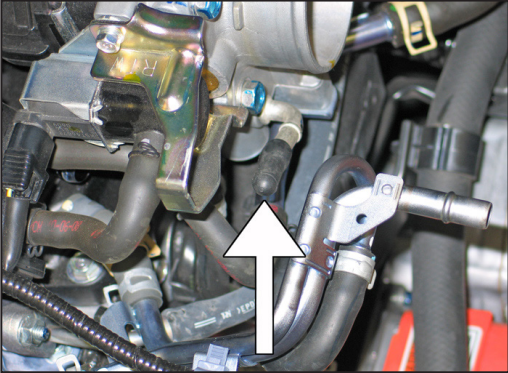

11. **Be sure the engine is cool before performing this step. Be sure to capture any released coolant.** Release the spring clamps securing the coolant bypass hose to the throttle body and the crankcase vent hose to the valve cover. Remove the bypass hose from the throttle body fitting, quickly plugging the outlet with a cap plug to prevent coolant loss. Remove the crankcase vent hose from the valve cover.

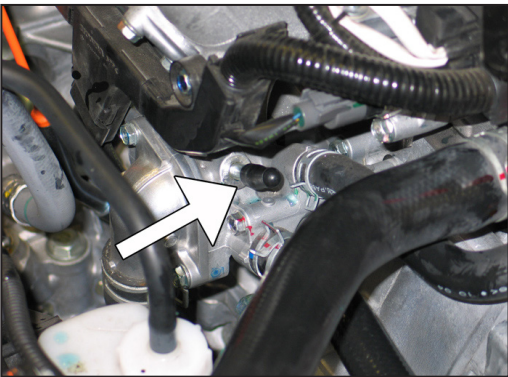

12. Release the spring clamp securing the coolant bypass hose to the thermostat housing. Remove the bypass hose from the thermostat housing fitting, quickly plugging the outlet with the remaining cap plug to prevent coolant loss. Remove the bypass/crankcase vent hose assembly from the vehicle.

NOTE: Be sure to capture any released coolant.



13. Route the provided bypass hose through the factory retaining clip as shown.

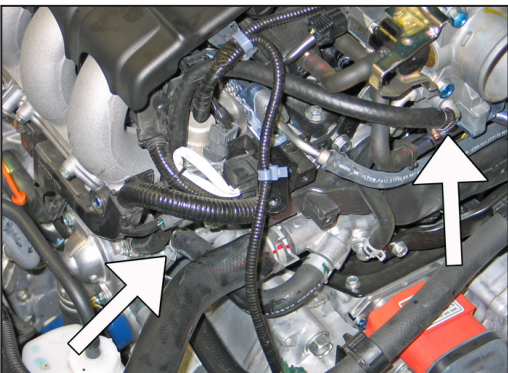

14. Remove the cap plugs and install the bypass hose onto the coolant fittings and secure with the provided hose clamps.
NOTE: Be sure to replenish the captured coolant into the reservoir.

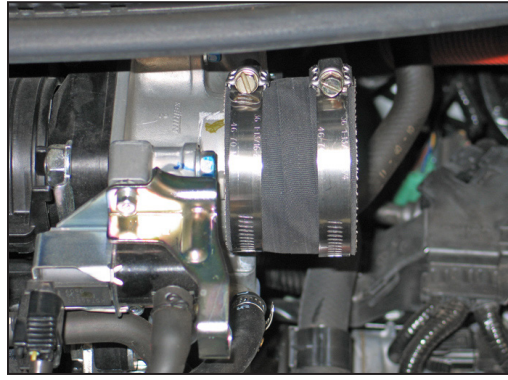

15. Install the provided silicone hose (08284) onto the throttle body and secure with the provided hose clamp.

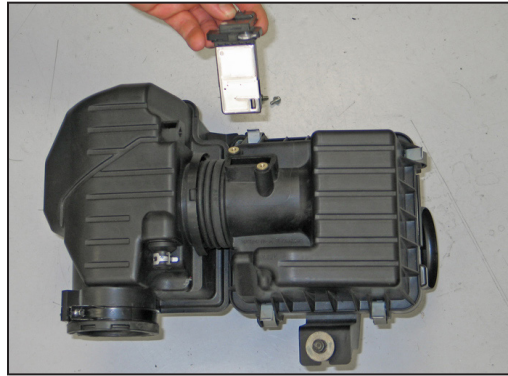

16. Remove the two screws securing the mass air sensor into the factory airbox, and then remove the mass air sensor.

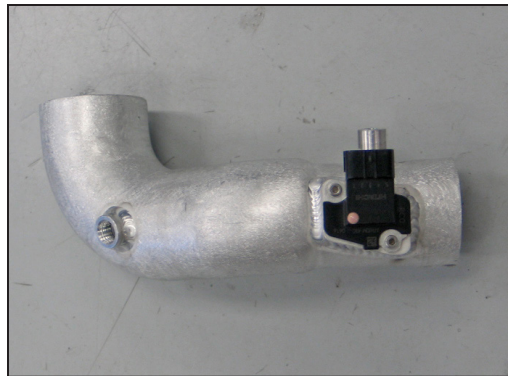

17. Install the mass air sensor into the K&N® intake tube and secure with the provided hardware.

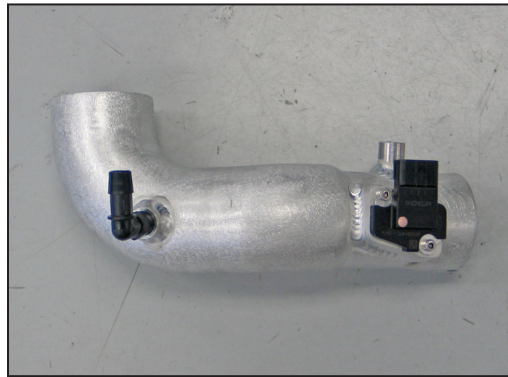

18. Install the provided 90° vent fitting into the K&N® intake tube as shown.
NOTE: Plastic NPT fittings are easy to cross thread. Install the vent fitting "hand" tight, then turn it two complete turns with a wrench.

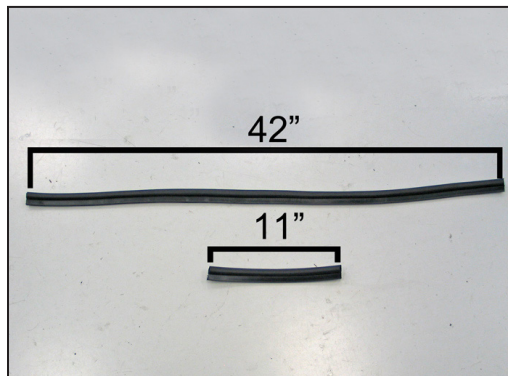

19. Cut the provided edge trim into two sections. One section will be 11" long; the other section will be cut to a length of 42".



20. Install the 42" long edge trim around the heat shield.

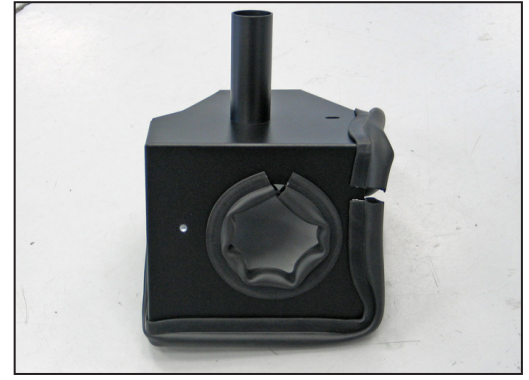

21. Install the 11" long edge trim into the hole of the heat shield.

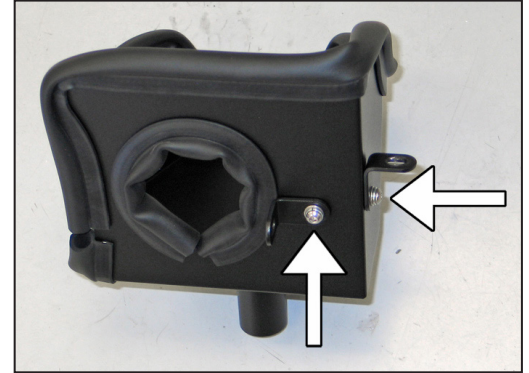

22. Install the provided "L" brackets (070066) onto the heat shield as shown using the provided hardware.

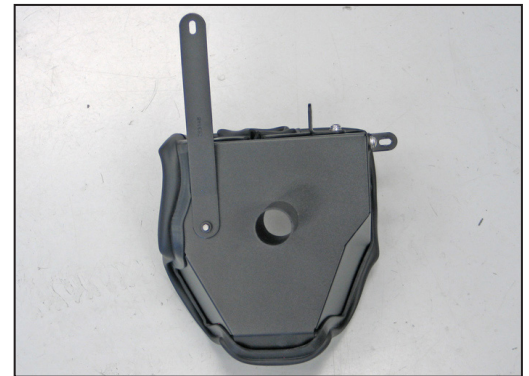

23. Install the flat bracket (083148) onto the heat shield as shown using the provided hardware.



24. Install the K&N® intake tube into the heat shield and secure to the mounting bracket with the provided hardware.

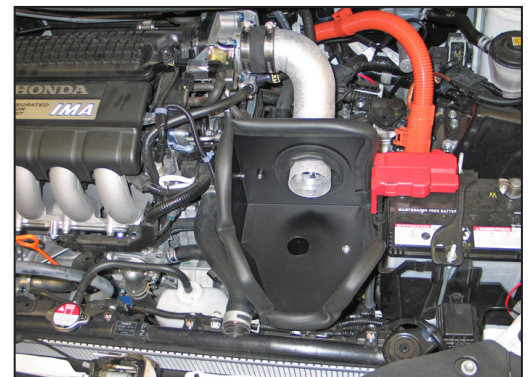

25. Install the heat shield/tube assembly into position and install the lower air duct onto the tube on the heat shield. Secure the heat shield to the factory airbox mounting locations with the hardware provided. Then secure the intake tube to the throttle body hose with the provided hose clamp.

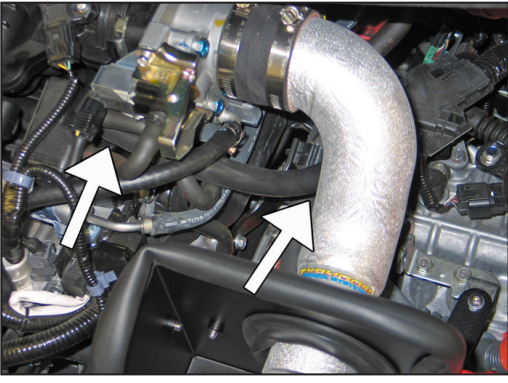

26. Attach the provided crankcase vent hose to the valve cover port, and then attach the open end to the 90° fitting in the intake tube.

NOTE: Some trimming of the crankcase vent hose will be necessary.



27. Install the K&N® air filter onto the intake tube and secure with the provided hose clamp.

NOTE: Drycharger® air filter wrap; part # RX-4990DK is available to purchase separately. To learn more about Drycharger® filter wraps or look up color availability please visit <http://www.knfilters.com>®.

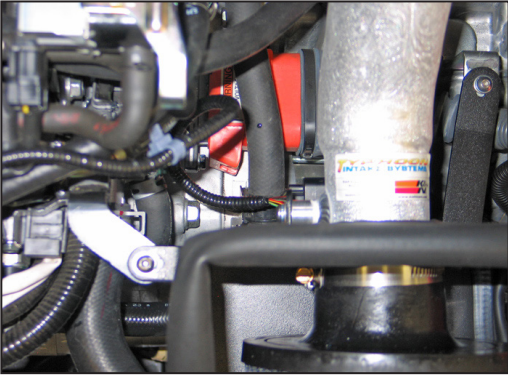

28. Reconnect the mass air sensor electrical connection.

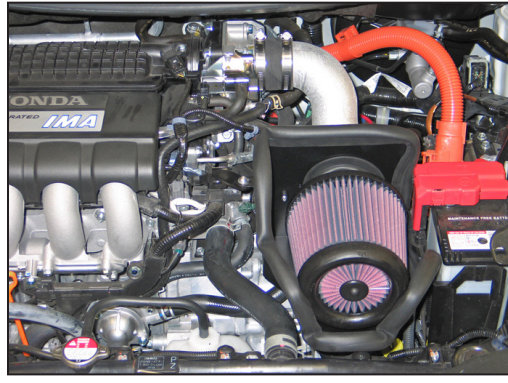

29. Reconnect the vehicle's negative battery cable. Double check to make sure everything is tight and properly positioned before starting the vehicle.

30. It will be necessary for all K&N® high flow intake systems to be checked periodically for realignment, clearance and tightening of all connections. Failure to follow the above instructions or proper maintenance may void warranty.

ROAD TESTING:

1. Start the engine with the transmission in neutral or park, and the parking brake engaged. Listen for air leaks or odd noises. For air leaks secure hoses and connections. For odd noises, find cause and repair before proceeding. This kit will function identically to the factory system except for being louder and much more responsive.

2. Test drive the vehicle. Listen for odd noises or rattles and fix as necessary.

3. If road test is fine, you can now enjoy the added power and performance from your kit.

4. K&N Engineering, Inc., requires cleaning the intake system's air filter element every 100,000 miles. When used in dusty or off-road environments, our filters will require cleaning more often. We recommend that you visually inspect your filter once every 25,000 miles to determine if the screen is still visible. When the screen is no longer visible some place on the filter element, it is time to clean it. To clean and re-oil, purchase our filter Recharger® service kit, part number 99-5050 or 99-5000 and follow the easy instructions.

NOT LEGAL FOR SALE OR USE ON ANY POLLUTION CONTROLLED MOTOR VEHICLE IN CALIFORNIA OR STATES ADOPTING CALIFORNIA EMISSION PROCEDURES.

See knfilters.com for CARB status on each part for a specific vehicle