



TYPHOON INTAKE SYSTEMS

INTAKE SYSTEMS FOR VEHICLES LISTED ARE 50 STATE LEGAL. SEE KNFILTERS.COM FOR CARB STATUS ON EACH PART FOR A SPECIFIC VEHICLE.

INSTALLATION INSTRUCTIONS

69-1016-1TS
HONDA
2007-08 Fit
L4-1.5L

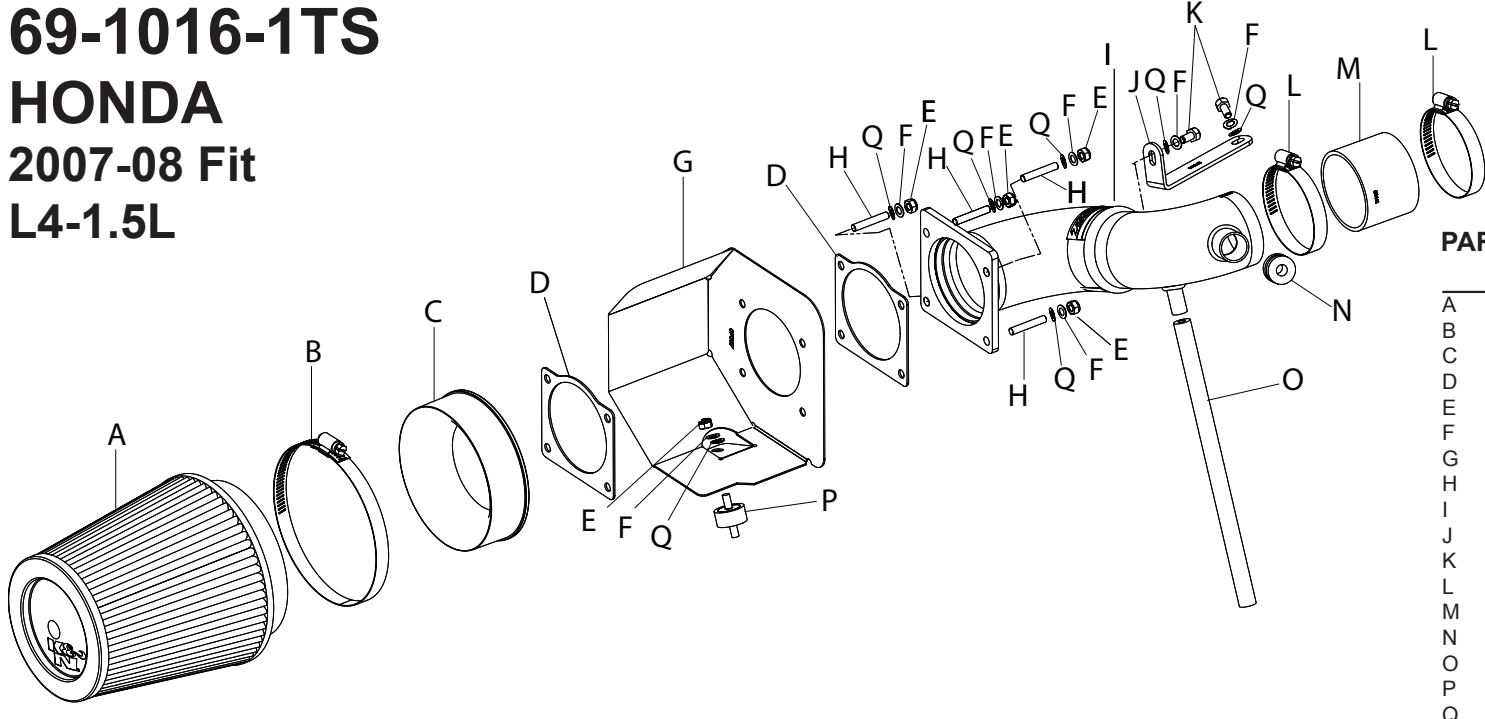

- TOOLS NEEDED**
- Ratchet
 - Extension 14"
 - 10mm Socket
 - Flat Head Screwdriver
 - Phillips Head Screwdriver
 - Pliers
 - Socket 5.5mm
 - Socket 8mm

PARTS LIST

Description	Qty.	P/N
A	1	RU-5163
B	1	08694
C	1	21510
D	2	09202
E	5	07512
F	7	08277
G	1	07649
H	4	08220
I	1	27519
J	1	010045
K	2	07727
L	2	08554
M	1	08284
N	1	08100
O	1	08404
P	1	07027
Q	7	08269

NOTE: FAILURE TO FOLLOW INSTALLATION INSTRUCTIONS AND NOT USING THE PROVIDED HARDWARE MAY DAMAGE THE INTAKE TUBE, THROTTLE BODY AND ENGINE.

TO START:



1. Turn off the ignition and disconnect the negative battery cable.
NOTE: Disconnecting the negative battery cable erases pre-programmed electronic memories. Write down all memory settings before disconnecting the negative battery cable. Some radios will require an anti-theft code to be entered after the battery is reconnected. The anti-theft code is typically supplied with your owner's manual. In the event your vehicles' anti-theft code cannot be recovered, contact an authorized dealership to obtain your vehicles anti-theft code.



2. Unplug the air temperature sensor from the harness clip.

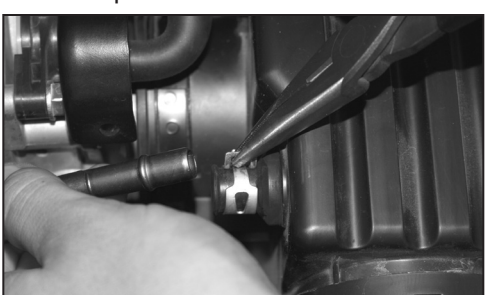

3. With pliers, depress the hose clamp and remove the crankcase vent (CCV) hose.



4. Unclip the fresh air duct.

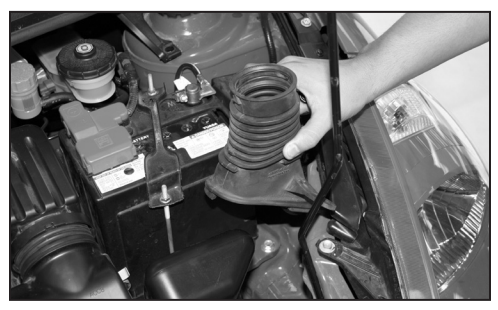

5. Separate the fresh air duct from the factory intake and completely remove.

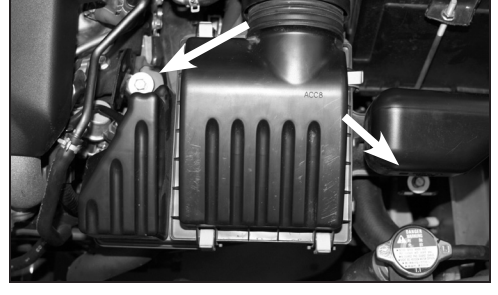

6. Loosen and remove the 2 bolts that secure the factory airbox to the vehicle.

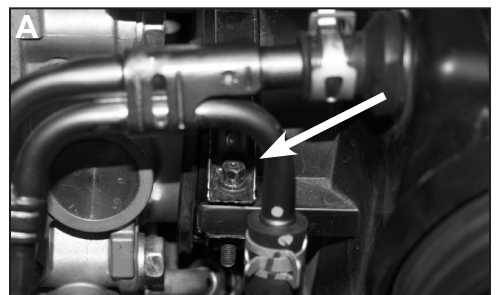

7. Loosen the hose clamp at the throttle body.



8. Remove the factory airbox by pulling away from the throttle body and lifting upwards.



8. Remove the factory airbox by pulling away from the throttle body and lifting upwards.

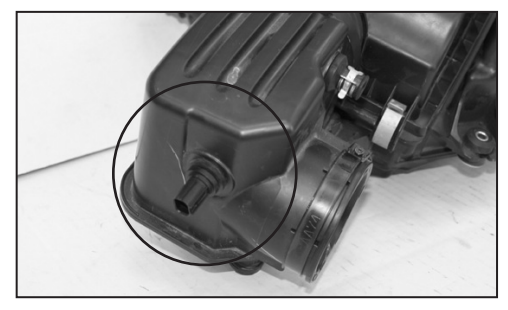

9. Remove the air temperature sensor from the factory airbox.



10. Push the provided grommet into the air temp sensor vent tube on the K&N intake tube. Then install the air temp sensor into the grommet.



10. Push the provided grommet into the air temp sensor vent tube on the K&N intake tube. Then install the air temp sensor into the grommet.



11. Install the provided threaded studs into the filter adaptor.



12. Install the gasket onto the filter adaptor as shown.



13. Attach the K&N® air filter to the adaptor assembly, and tighten the hose clamp.

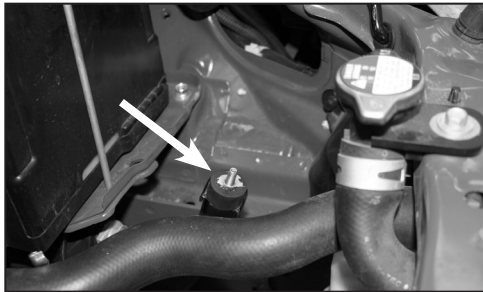

14. Install the provided rubber mounted stud into the threaded hole where the factory airbox was mounted.

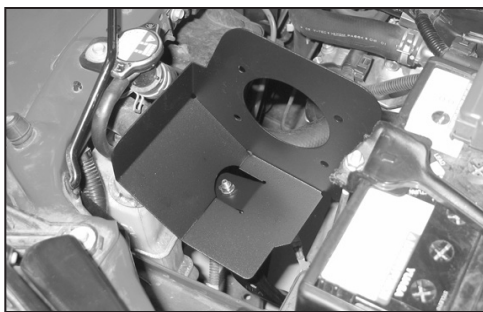

15. Place the heat shield onto the rubber mounted stud, then place the provided hardware. Pivot the heat shield around.

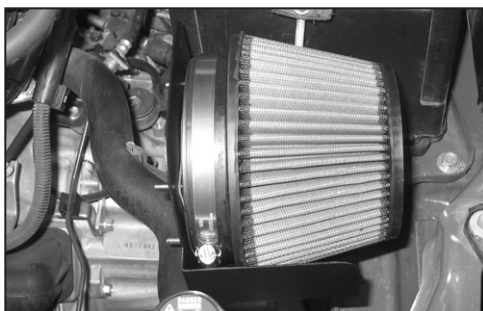

16. Place the filter assembly on the heat shield as shown. Tighten the lock nut on the vibration mount. **NOTE: Heat shield should be perpendicular (90 degrees) to the battery. It may be necessary to loosen the battery and move it back to gain clearance for the heat shield**



17. Attach the silicone hose to the throttle body with the hose clamps provided.

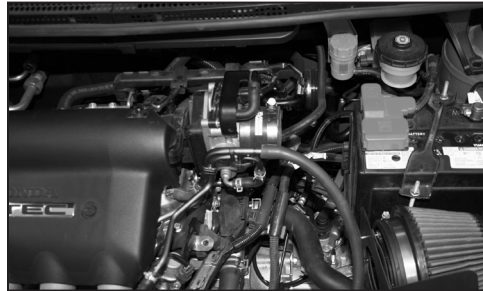

18. Attach the silicone hose to the crankcase vent hose on the engine valve cover as shown.

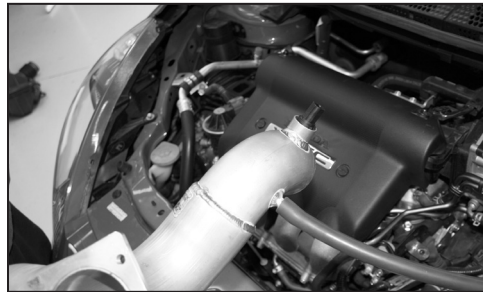

19. Install the other end of the silicone hose to the vent line on the K&N® intake tube.



20. Place the gasket on the heat shield, as shown.

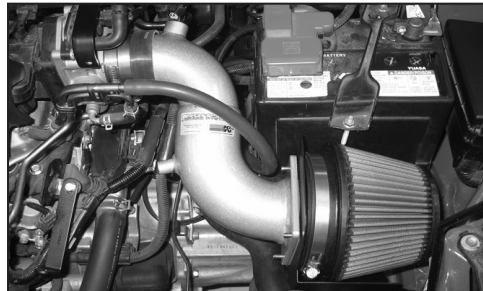

21. Install the K&N® intake tube on the heat shield first, then to the hose on the throttle body.

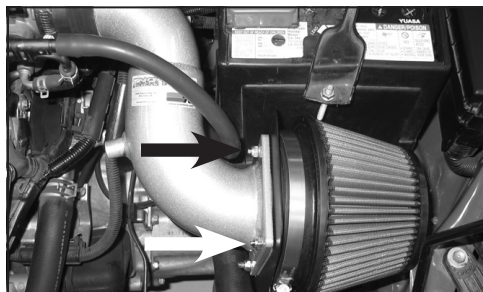

22. Secure the K&N® intake tube to the heat shield using the provided hardware.

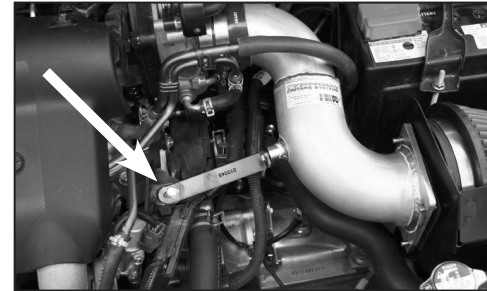

23. Install the "L" bracket and secure with the provided hardware.

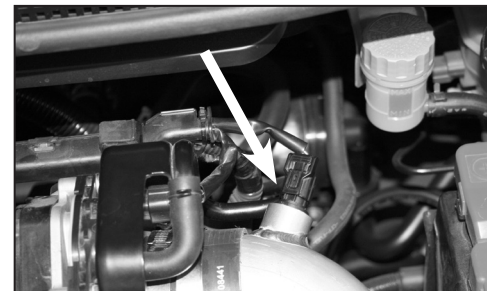

24. Clip the ATS harness into the air temperature sensor.



25. Check for best fit, then tighten all hardware and hose clamps.

26. Reconnect the vehicle's negative battery cable. Double check to make sure everything is tight and properly positioned before starting the vehicle.

27. The C.A.R.B. exemption sticker, (attached), must be visible under the hood so that an emissions inspector can see it when the vehicle is required to be tested for emissions. California requires testing every two years, other states may vary.

28. It will be necessary for all K&N® high flow intake systems to be checked periodically for realignment, clearance and tightening of all connections. Failure to follow the above instructions or proper maintenance may void warranty.

ROAD TESTING:

1. Start the engine with the transmission in neutral or park, and the parking brake engaged. Listen for air leaks or odd noises. For air leaks secure hoses and connections. For odd noises, find cause and repair before proceeding. This kit will function identically to the factory system except for being louder and much more responsive.

2. Test drive the vehicle. Listen for odd noises or rattles and fix as necessary.

3. If road test is fine, you can now enjoy the added power and performance from your kit.

4. K&N Engineering, Inc., suggests checking the air filter element periodically for excessive dirt build-up. When the element becomes covered in dirt (or once a year), service it according to the instructions on the Recharger® service kit, part number 99-5050 or 99-5000.

INTAKE SYSTEMS FOR VEHICLES LISTED ARE 50 STATE LEGAL. SEE KNFILTERS.COM FOR CARB STATUS ON EACH PART FOR A SPECIFIC VEHICLE.