



FUEL INJECTION PERFORMANCE KIT FIPIK GENERATION II™

INTAKE SYSTEMS FOR VEHICLES LISTED ARE 50 STATE LEGAL. SEE KNFILTERS.COM FOR CARB STATUS ON EACH PART FOR A SPECIFIC VEHICLE.

INSTALLATION INSTRUCTIONS

57-9015-1
TOYOTA
1999-04 Tacoma
1999-02 4Runner
V6-3.4L

NOTE: This kit was not designed to fit vehicles with a body lift.

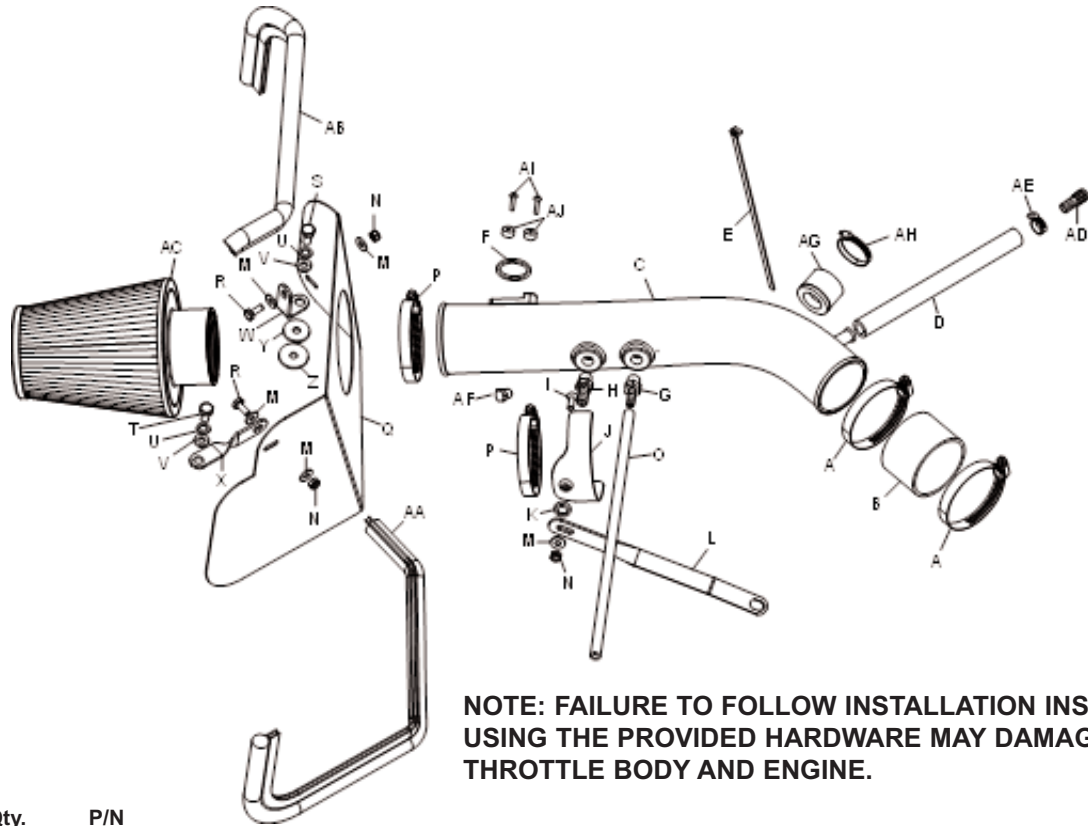

NOTE: FAILURE TO FOLLOW INSTALLATION INSTRUCTIONS AND NOT USING THE PROVIDED HARDWARE MAY DAMAGE THE INTAKE TUBE, THROTTLE BODY AND ENGINE.

TOOLS NEEDED:

- ratchet
- long extension
- 12mm socket
- 13mm socket
- Phillips screw driver
- 5/8" wrench
- side cutters
- 14mm wrench
- 10mm wrench
- 4mm allen
- drill
- 1-3/8" hole saw

PARTS LIST:

Description	Qty.	P/N	Description	Qty.	P/N	Description	Qty.	P/N
A Hose Clamp #44	2	08577	M Washer 1/4"ID x 5/8"OD	5	08275	Y Washer 5/16 - 1.25 Fender	1	08130
B Silicone Hose	1	08756	N Nut 6mm Nylock	3	07553	Z Washer 1.25 x .30 x .10	1	21708
C Intake Tube	1	087200	O Silicone Hose 6mm x 16"L	1	08170	AA Edge Trim 26"L	1	102488
D Silicone Hose 1/2"ID x 9"L	1	08401	P Hose Clamp #48	2	08601	AB Edge Trim 20"L	1	102494
E Cable Tie	1	21591	Q Heat Shield	1	07435	AC Air Filter	1	RC-4700
F Gasket	1	09013	R Bolt M6 - 1.00 x 16mm Hex	2	07703	AD Hose Mender 1/2" to 5/8"	1	08726
G Vent 1/4" Hose, 1/4" NPT	1	08046	S Bolt 8mm-1.25 x 16 Hex	1	07844	AE Hose Clamp #6 MIDI	1	08407
H Vent 3/8" Hose, 1/4" NPT	1	08047	T Bolt 8mm - 1.25 x 20mm Hex	1	07787	AF 1/4 NPT Plug	1	08032
I Bolt 6mm-1.00 x 20mm F/H/A	1	08376	U Washer (Wave)	2	08239	AG Grommet; 2"OD, 1.20ID, .130 Groove	1	08286
J Saddle Bracket	1	078855	V Washer 5/16"ID x 5/8"OD	2	08276	AH Hose Clamp #24	1	08460
K Washer, Conical Nylon	1	08180	W Bracket "L" Bend	1	070712	AI Screw; M4-.7x16mm	2	07793
L Bracket	1	070561	X Bracket Short Twist	1	070702	AJ Spacer; .500"ODX.171"IDX.250"	2	06531

TO START:

1. Turn the ignition OFF and disconnect the vehicle's negative battery cable.
NOTE: Disconnecting the negative battery cable erases pre-programmed electronic memories. Write down all memory settings before disconnecting the negative battery cable. Some radios will require an anti-theft coded to be entered after the battery is reconnected. The anti-theft code is typically supplied with your owner's manual. In the event your vehicles' anti-theft code cannot be recovered, contact an authorized dealership to obtain your vehicles anti-theft code.



2. Disconnect the mass air sensor.

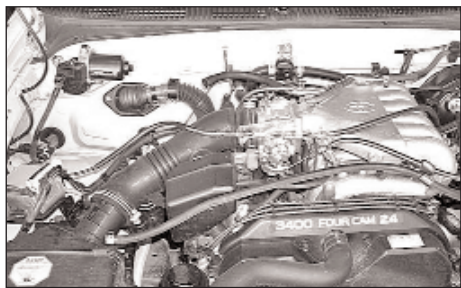

3. Disconnect the three hoses from the air box resonator and intake hose.
NOTE: Some 03 models may only come equipped with two vent lines.

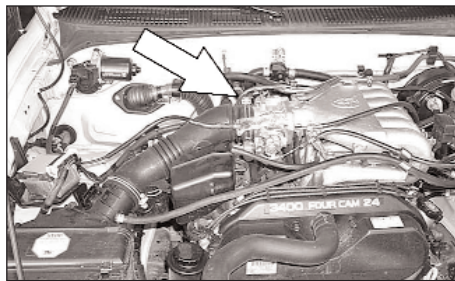

4. Loosen the hose clamps at the throttle body.

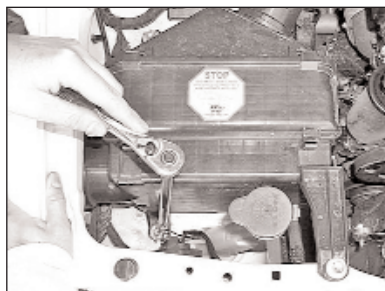

5. Loosen the three bolts that retain the air box assembly.



6. Remove the complete air intake system.
NOTE: K&N Engineering, Inc., recommends that customers do not discard factory air intake.

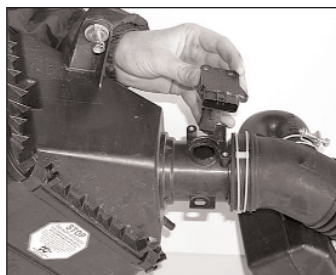

7. Loosen and remove the screws that secure the mass air sensor, then remove the mass air sensor.

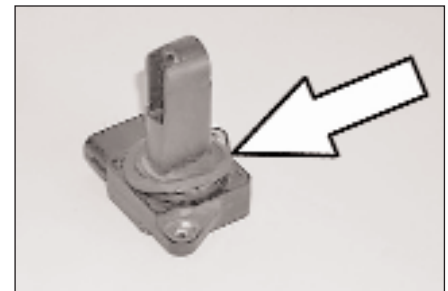

8. Apply the provided gasket to the mass air sensor, with the sticky side down.

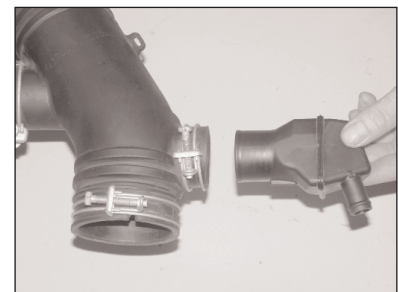

8a. On vehicles equipped with the crank case vent resonator chamber, loosen the hose clamp which secures the chamber to the intake tube and remove the chamber from the tube as shown.

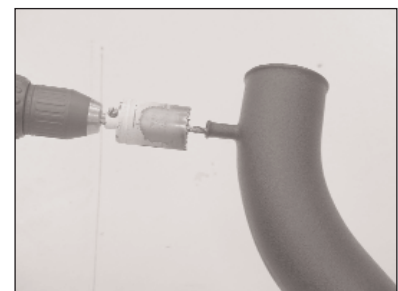

8b. On vehicles equipped with the crank case resonator chamber, using a 1-3/8" hole saw, drill out the 5/8" vent port as shown.
NOTE: Be sure to remove any burrs in the hole after drilling.



8c. Install the resonator grommet provided into the 1-3/8" hole drilled in step #8 as shown.
NOTE: Be sure to remove any burrs in the hole after drilling.

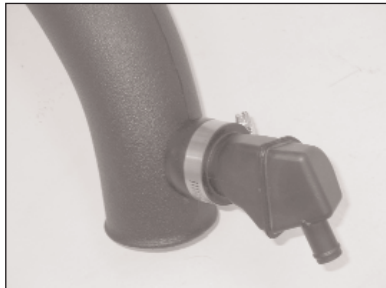

8d. Install the crank case vent resonator into the grommet installed in step #8c and secure with the provided hose clamp.

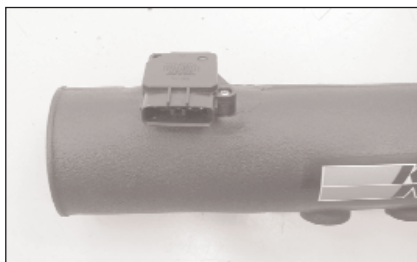

9. Install the mass air sensor into the K&N® intake tube using screws and spacers provided.



10. Install the provided vents into the K&N® intake tube.
NOTE: Plastic NPT fittings are easy to cross thread. Install the vent fitting "hand" tight, then turn it two complete turns with a wrench.



10a. On models that come equipped with one vent line install provided plug into the K&N® intake tube as shown.

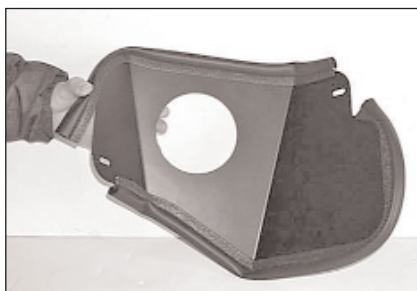

11. Install the two pieces of edge trim onto the heat shield as shown above.



12. Install the "L" bracket onto the existing air box-mounting hole.
NOTE: Rubber washer & fender washer should be mounted between the fender and the bracket. Do not tighten completely.

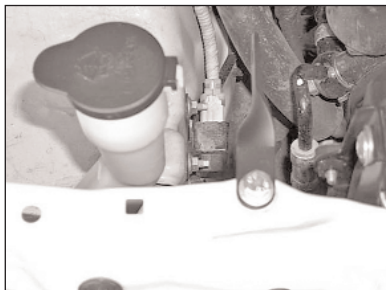

13. Install the twist bracket onto the existing air box-mounting hole with the provided hardware as shown. Do not tighten completely.



14a. On 1999, and on 2003 and later vehicles assemble the saddle bracket as shown above.



14b. On 2000-02 vehicles, assemble the saddle bracket as shown above.

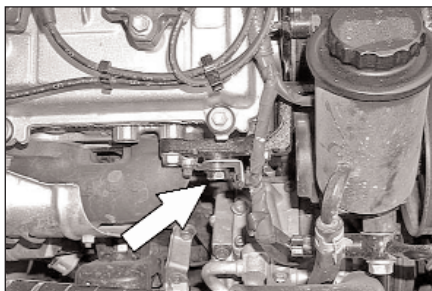

15. On 1999-2002 vehicles loosen and remove the bolt that secures the wire harness bracket located directly behind the power steering reservoir.

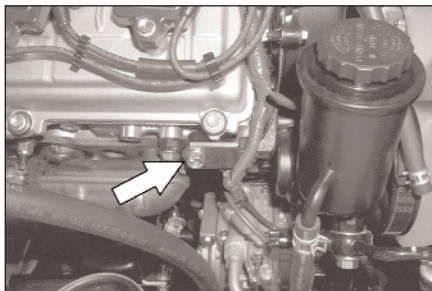

15a. On 2003 and later models, loosen and remove the bolt that secures the wire harness bracket located directly behind the power steering reservoir.

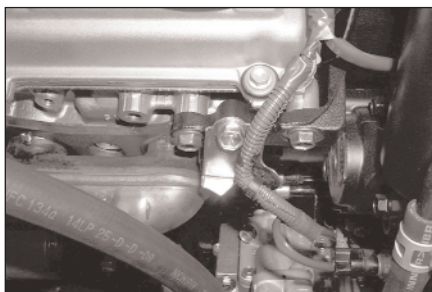

15b. On 2003 and later models, remove wire harness from bracket then turn bracket over and mount to engine as shown, then re-install wire harness.

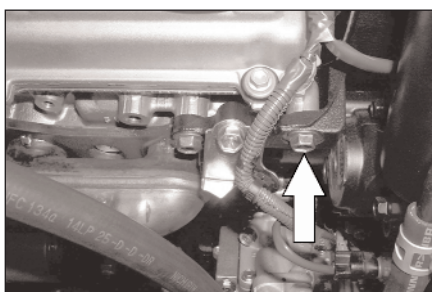

15c. On 2003 models, remove the bolt from power steering bracket as shown

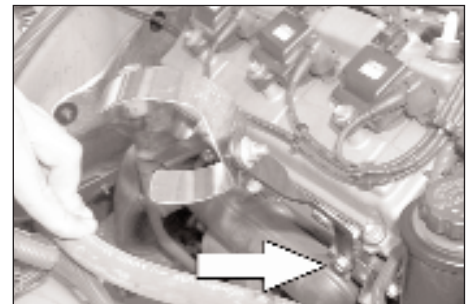

16. On 1999-2002 vehicles install the saddle bracket assembly onto the motor using the bolt from step 15. Do not tighten completely.

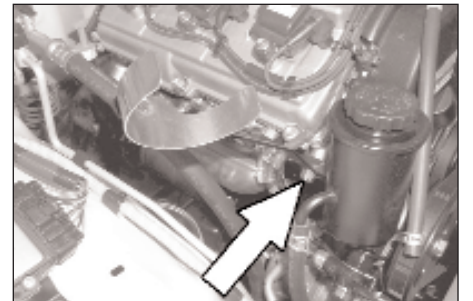

16a. On 2003 and later vehicles, install the saddle bracket assembly onto the motor using the bolt from step 15c. Do not tighten completely.

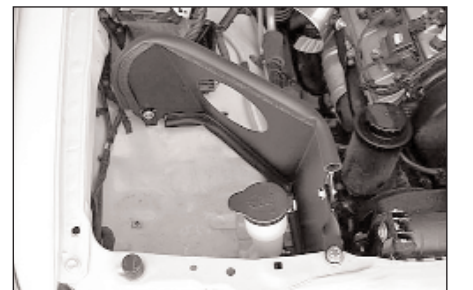

17. Install the heat shield and secure it to the new K&N® brackets with the hardware provided as shown. Do not tighten completely.

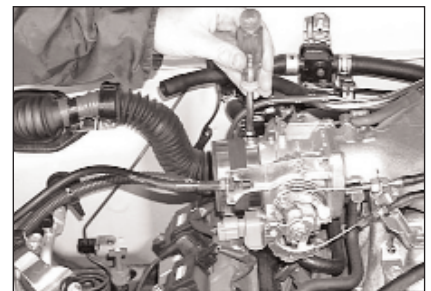

18. Install the silicone hose and hose clamps onto the throttle body as shown.



19. Install the K&N® intake tube onto the throttle body, and then tighten the hose clamps at the throttle body and saddle bracket.



20. Install the provided silicone hose onto the engine and connect it to the K&N® intake tube as shown then attach the vent line to the evap canister to the K&N® intake tube as shown.

NOTE: Some 03 models do not come equipped with a vent line that attaches to the EVAP canister.

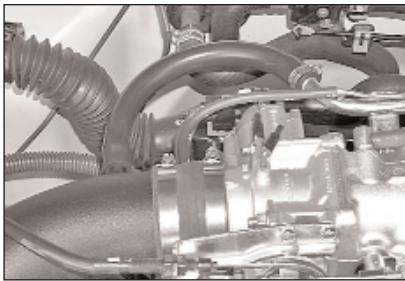

21. On 1999-00 models, attach the provided silicone hose onto the crankcase vent and connect it to the K&N® intake as shown.

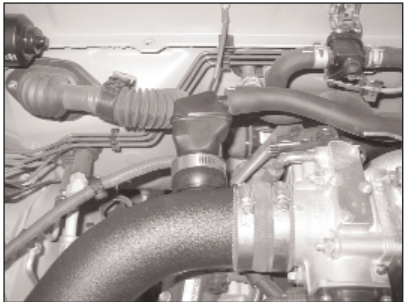

21a. On vehicles equipped with crank case vent resonator, connect the factory crank case vent hose onto the resonator as shown. **NOTE: The crank case vent hose may need to be repositioned to enable it to reach the resonator.**



22. Install the K&N® air filter onto the K&N® intake tube and secure it with the provided hose clamp. **NOTE: Drycharger® air filter wrap; part # RC-4700DK is available to purchase separately. To learn more about Drycharger® filter wraps or look up color availability please visit <http://www.knfilters.com>.**



23. Reconnect the mass air sensor.

24. Reconnect the vehicle's negative battery cable. Double check to make sure everything is tight and properly positioned before starting the vehicle.

25. The C.A.R.B. exemption sticker, (attached), must be visible under the hood so that an emissions inspector can see it when the vehicle is required to be tested for emissions. California requires testing every two years, other states may vary.

26. It will be necessary for all K&N® performance intake kits to be checked periodically for realignment, clearance and tightening of all connections. Failure to follow the above instructions or proper maintenance may void warranty.

ROAD TESTING:

1. Start the engine with the transmission in neutral or park, and the parking brake engaged. Listen for air leaks or odd noises. For air leaks secure hoses and connections. For odd noises, find cause and repair before proceeding. This kit will function identically to the factory system except for being louder and much more responsive.

2. Test drive the vehicle. Listen for odd noises or rattles and fix as necessary.

3. If road test is fine, you can now enjoy the added power and performance from your kit.

4. K&N Engineering, Inc., suggests checking the air filter element periodically for excessive dirt build-up. When the element becomes covered in dirt (or once a year), service it according to the instructions on the Recharger® service kit, part number 99-5000 or 99-5050.

INTAKE SYSTEMS FOR VEHICLES LISTED ARE 50 STATE LEGAL. SEE KNFILTERS.COM FOR CARB STATUS ON EACH PART FOR A SPECIFIC VEHICLE.