



INTAKE SYSTEMS FOR VEHICLES LISTED ARE 50 STATE LEGAL. SEE KNFILTERS.COM FOR CARB STATUS ON EACH PART FOR A SPECIFIC VEHICLE.

# INSTALLATION INSTRUCTIONS

**57-2566**  
**FORD**  
**2005-09 Mustang**  
**V6-4.0L**

**TOOLS NEEDED:**

- Flat Blade Screwdriver
- Ratchet
- Extension
- 8mm Socket
- 10mm Socket
- 15mm Socket
- 10mm Wrench

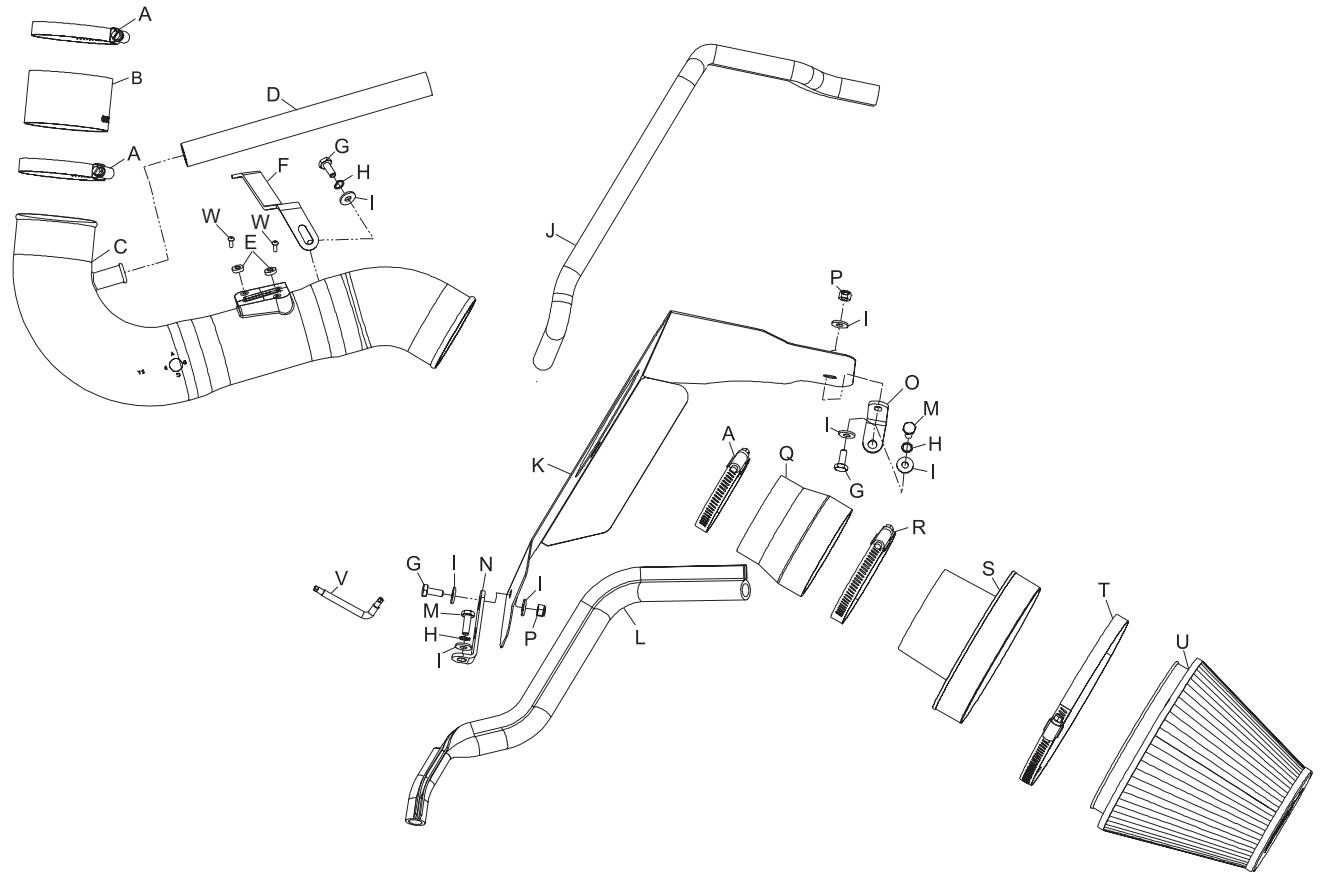

**PARTS LIST:**

Description	Qty.	Part #	Description	Qty.	Part #	Description	Qty.	Part #
A Hose Clamp #48	3	08601	I Washer; 1/4"ID x 5/8"OD, Flat	7	08275	Q Hose; Step, Black Silicone	1	08724
B Hose; Straight, Black Silicone	1	08434	J Edge Trim 30"	1	102489	R Hose Clamp; #56	1	08620
C Intake Tube	1	087168	K Heat Shield	1	074038	S Adapter #452	1	21518
D Hose; 5/8"ID x 9.75"L, Silicone	1	084047	L Edge Trim 23"	1	102495	T Hose Clamp; #104	1	08697
E Spacer; .437"OD x .2"ID	2	06503	M Bolt; 6mm-1.00 x 25mm, Hex	2	07704	U Air Filter	1	RF-1048
F Bracket	1	010110	N Bracket, "L"	1	07158	V Wrench, T20 "L" Key	1	69801
G Bolt; 6mm-1.00 x 16mm, Hex	3	07703	O Bracket, "L"	1	070812	W Screw; M4-.7 X 16mm, Button SS	2	07793
H Washer; 1/4" Split Lock	3	08198	P Nut; 6mm Nylock	2	07553			

**NOTE: FAILURE TO FOLLOW INSTALLATION INSTRUCTIONS AND NOT USING THE PROVIDED HARDWARE MAY DAMAGE THE INTAKE TUBE, THROTTLE BODY AND ENGINE.**

**TO START:**

1. Turn off the ignition and disconnect the negative battery cable.  
**NOTE: Disconnecting the negative battery cable erases pre-programmed electronic memories. Write down all memory settings before disconnecting the negative battery cable. Some radios will require an anti-theft code to be entered after the battery is reconnected. The anti-theft code is typically supplied with your owner's manual. In the event your vehicles' anti-theft code cannot be recovered, contact an authorized dealership to obtain your vehicles anti-theft code.**



2. Release the red locking tab and then disconnect the mass air sensor electrical connection.



3. Release the locking ring and then disconnect the crank case vent tube.



4. Loosen the hose clamps, which secure the intake tube to the throttle body and airbox, then remove the intake tube as shown.

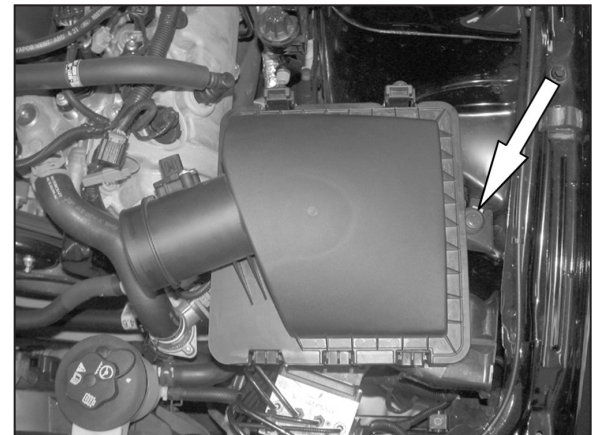

5. Remove the airbox mounting bolt shown.



6. Remove the airbox assembly as shown.  
**NOTE: K&N Engineering, Inc., recommends that customers do not discard factory air intake.**

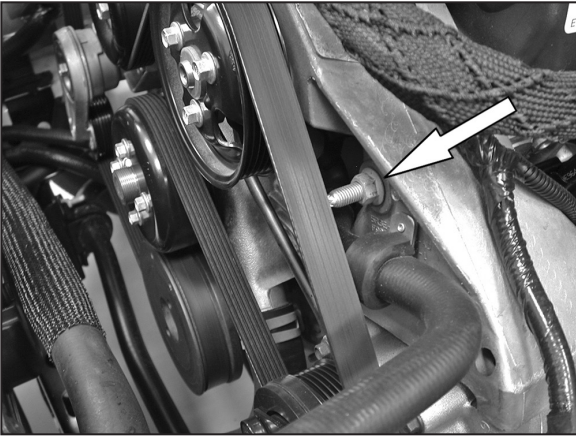

7. Remove the power steering pump bracket-retaining nut shown.

**NOTE: Nut will be reused.**



8. Install the tube-mounting bracket onto the power steering mounting bracket stud and secure with the nut removed in step #7.

**NOTE: Do not completely tighten at this time.**

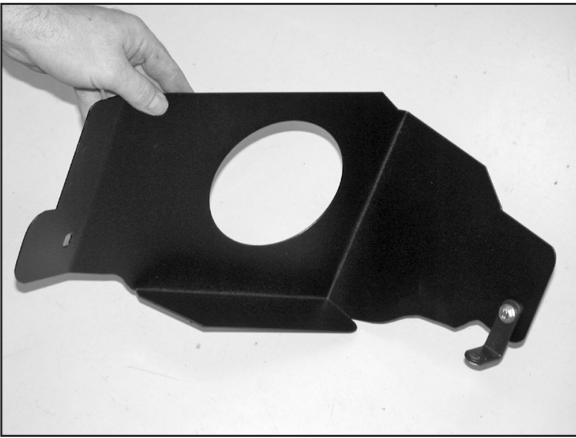

9. Install the "L" bracket (070812) onto the rear of the heat shield as shown with the provided hardware.



10. Install the "L" bracket (07158) onto the front of the heat shield as shown with the provided hardware.

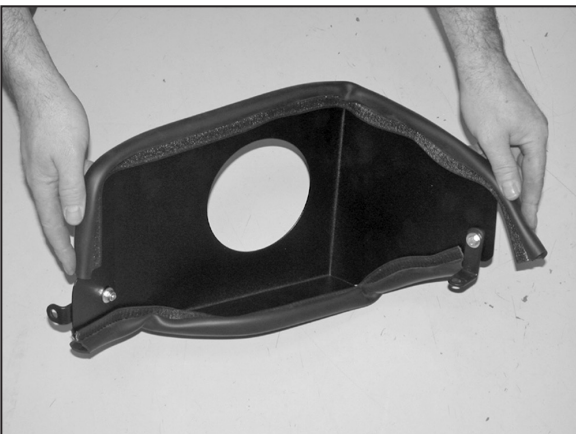

11. Install the edge trim onto the heat shield as shown.

**NOTE: Some trimming of the edge trim may be necessary for proper fit.**

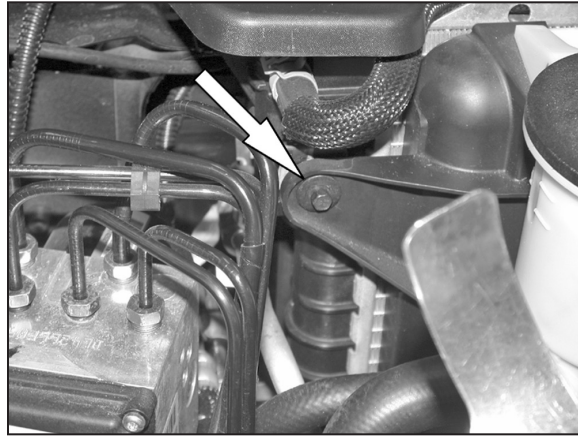

12. Remove the radiator fan shroud mounting bolt shown.

**NOTE: This bolt will not be reused.**

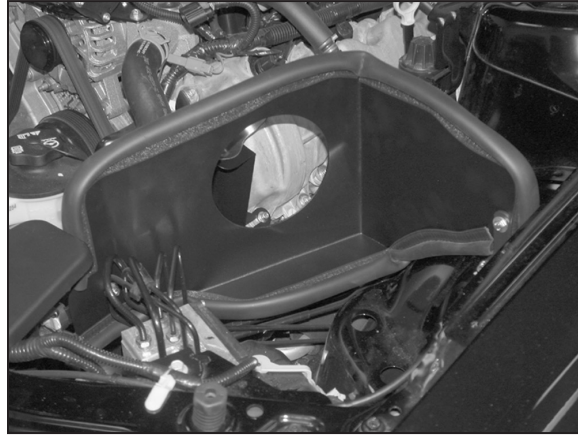

13. Install the heat shield and secure with the provided hardware as shown.

**NOTE: The forward mounting bracket will mount to the radiator fan shroud mounting location and the rear bracket will mount to the airbox mounting location.**

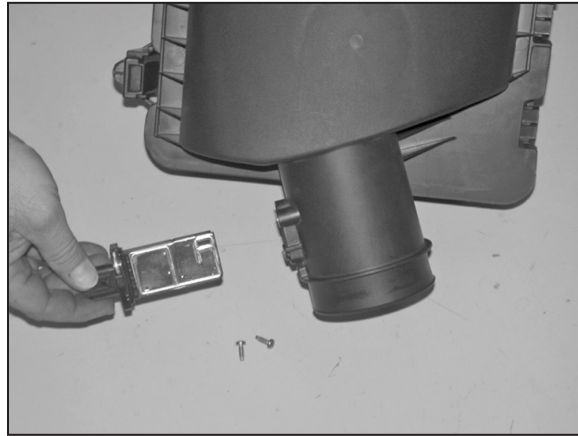

14. Remove the mass air sensor from the factory airbox with the T20 "TORX" wrench provided.



15. Install the mass air sensor into the K&N® intake tube with the mounting screws and two spacers provided.

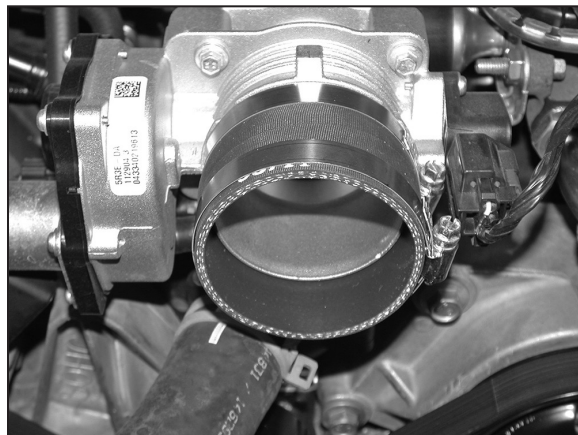

16. Install the silicone hose (08434) onto the throttle body with the provided hose clamps as shown.



17. Install the K&N® intake tube into the silicone hose at the throttle body and onto the tube-mounting bracket installed in step #8, secure with provided hardware.



18. Using a razor blade cut the crankcase vent tube 6" from the end as shown.



19. Install the provided crankcase vent hose onto the K&N® intake tube and factory vent hose as shown.



20. Install the air filter onto the filter adapter and secure with the provided hose clamp as shown. **NOTE: Drycharger® air filter wrap; part # RF-1048DK is available to purchase separately. To learn more about Drycharger® filter wraps or look up color availability please visit <http://www.knfilters.com>.**



21. Install the silicone hose (08724) onto the air filter assembly and secure with the provided hose clamp as shown.

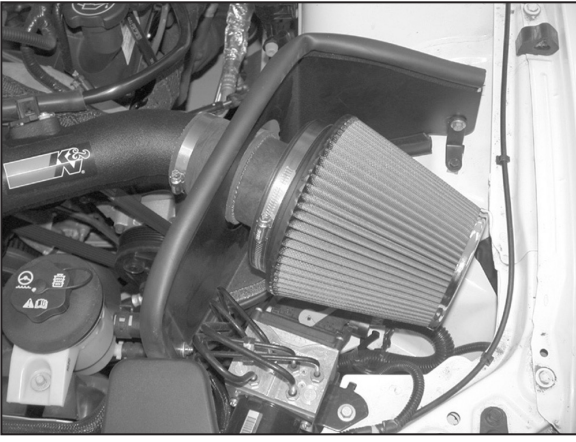

22. Install the air filter assembly onto the K&N® intake tube as shown and secure with the provided hose clamp.



23. Reconnect the mass air sensor electrical connection as shown.



24. Reconnect the vehicle's negative battery cable. Double check to make sure everything is tight and properly positioned before starting the vehicle.

25. The C.A.R.B. exemption sticker, (attached), must be visible under the hood so that an emissions inspector can see it when the vehicle is required to be tested for emissions. California requires testing every two years, other states may vary.

26. It will be necessary for all K&N® high flow intake systems to be checked periodically for realignment, clearance and tightening of all connections. Failure to follow the above instructions or proper maintenance may void warranty.

#### ROAD TESTING:

1. Start the engine with the transmission in neutral or park, and the parking brake engaged. Listen for air leaks or odd noises. For air leaks secure hoses and connections. For odd noises, find cause and repair before proceeding. This kit will function identically to the factory system except for being louder and much more responsive.

2. Test drive the vehicle. Listen for odd noises or rattles and fix as necessary.

3. If road test is fine, you can now enjoy the added power and performance from your kit.

4. K&N Engineering, Inc., requires cleaning the intake system's air filter element every 100,000 miles. When used in dusty or off-road environments, our filters will require cleaning more often. We recommend that you visually inspect your filter once every 25,000 miles to determine if the screen is still visible. When the screen is no longer visible some place on the filter element, it is time to clean it. To clean and re-oil, purchase our filter Recharger® service kit, part number 99-5050 or 99-5000 and follow the easy instructions.

**INTAKE SYSTEMS FOR VEHICLES LISTED ARE 50 STATE LEGAL. SEE KNFILTERS.COM FOR CARB STATUS ON EACH PART FOR A SPECIFIC VEHICLE.**