



INTAKE SYSTEMS FOR VEHICLES LISTED ARE 50 STATE LEGAL. SEE KNFILTERS.COM FOR CARB STATUS ON EACH PART FOR A SPECIFIC VEHICLE.

INSTALLATION INSTRUCTIONS

57-2557
FORD
2004-05 F-150
V8-4.6L

NOTE: This kit was not designed to fit vehicles with a body lift.

TOOLS NEEDED:

- Flat Blade Screwdriver
- Ratchet
- Extension
- 10mm socket
- 13mm Socket
- 9/16" Socket
- 10mm Wrench
- 13mm Wrench

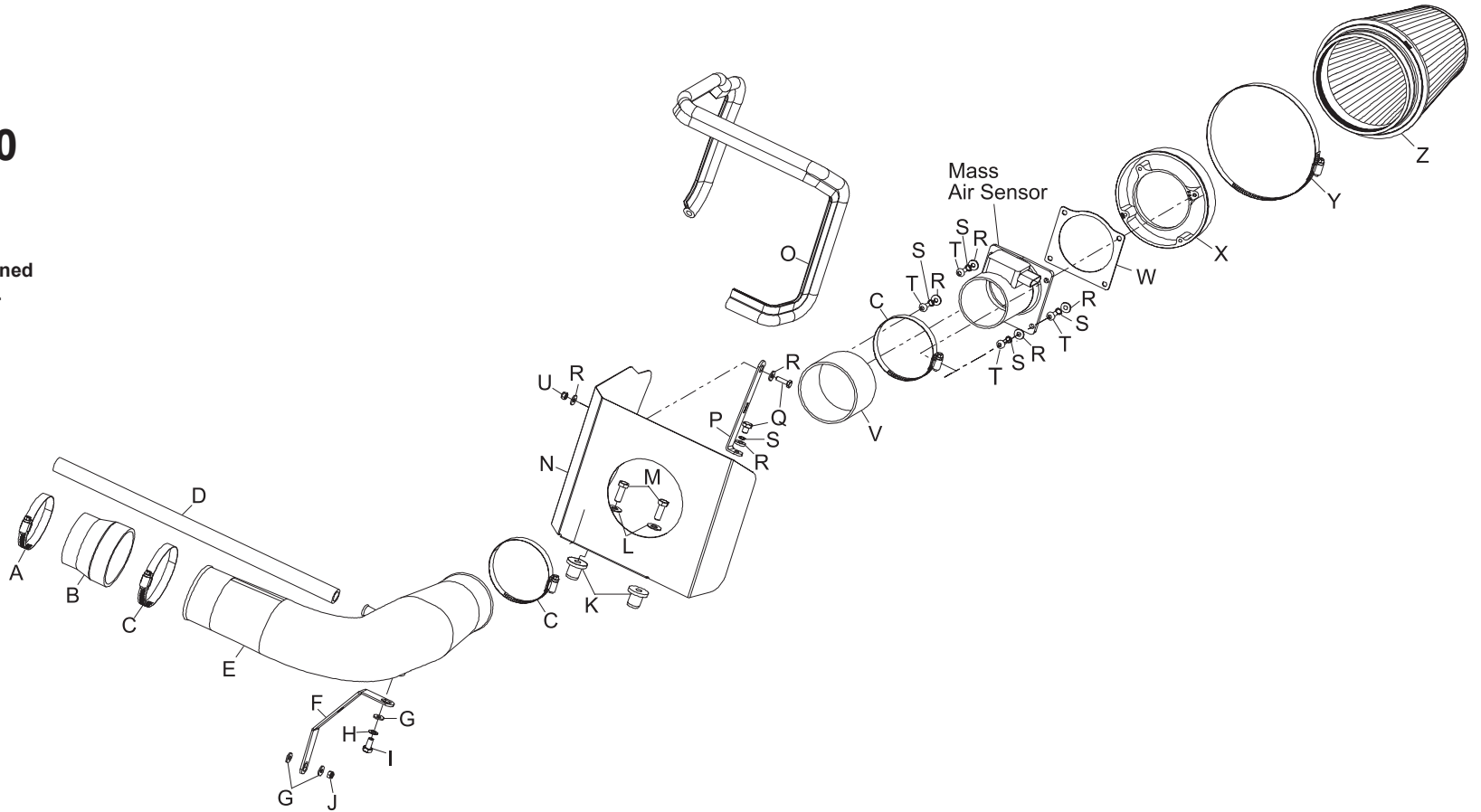

PARTS LIST:

Description	Qty.	Part #	Description	Qty.	Part #	Description	Qty.	Part #
A hose clamp #48	1	08601	J nut 8mm nylock	1	07542	S washer, 1/4", lock	5	08198
B silicone hose	1	08724	K insert; 3/8"-16x3/4"x15/16"L	2	08163	T bolt, 6mm-1.00 x 16mm, bha	4	07730
C hose clamp #56	3	08620	L washer; 3/8" id, flat, ss	2	08134	U nut, 6mm, nylock	1	07553
D silicone hose 5/8id X 19"L	1	08611	M bolt; 3/8"-16 x 1.25"L, ss, hex	2	07779	V silicone hose	1	08626
E intake tube (DV)	1	087118	N heat shield	1	074021	W gasket, mass air sensor	1	09984
F bracket	1	07198	O edge trim 55"	1	102480	X filter adapter #250	1	08785
G washer, 5/16" id x 5/8 od, flat	3	08276	P bracket	1	070026	Y hose clamp #104	1	08697
H washer, 8mm, wave	1	08239	Q bolt, 6mm-1.00x16mm, hex	2	07703	Z air filter	1	RF-1020
I bolt, 8mm-1.25 x 16mm, hex	1	07844	R washer; 1/4" id x 5/8" od, flat	7	08275			

NOTE: FAILURE TO FOLLOW INSTALLATION INSTRUCTIONS AND NOT USING THE PROVIDED HARDWARE MAY DAMAGE THE INTAKE TUBE, THROTTLE BODY AND ENGINE.

TO START:

1. Turn off the ignition and disconnect the negative battery cable.
NOTE: Disconnecting the negative battery cable erases pre-programmed electronic memories. Write down all memory settings before disconnecting the negative battery cable. Some radios will require an anti-theft code to be entered after the battery is reconnected. The anti-theft code is typically supplied with your owner's manual. In the event your vehicles' anti-theft code cannot be recovered, contact an authorized dealership to obtain your vehicles anti-theft code.



2. Rotate the crank case vent hose locking ring and pull the crank case vent hose off of the valve cover.

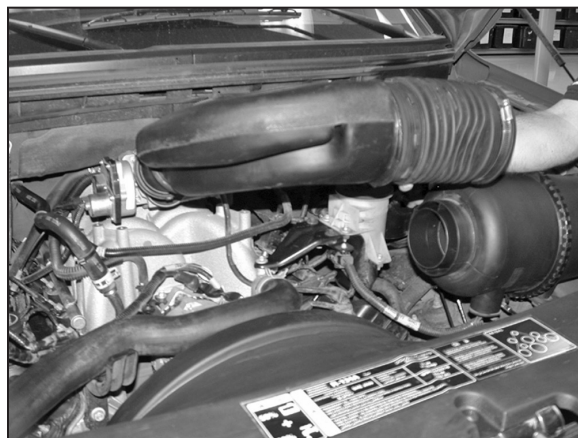

3. Loosen the stock intake tube hose clamps, and remove the intake tube from vehicle.



4. Unhook the secondary mass air sensor electrical connection from the power steering reservoir bracket, then unlock the electrical connection locking tabs and separate the electrical connection



5. Pull firmly up on the air filter assembly to remove it from the mounting grommets.

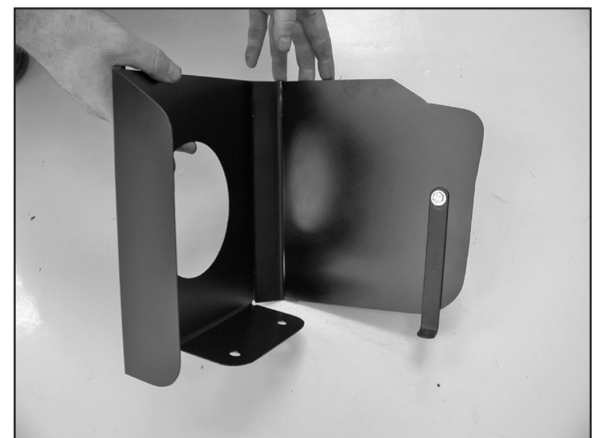

6. Install "L" bracket (070026) onto the heatshield with the hardware provided as shown.



7. Install the edge trim onto the heatshield as shown. Trim if needed.

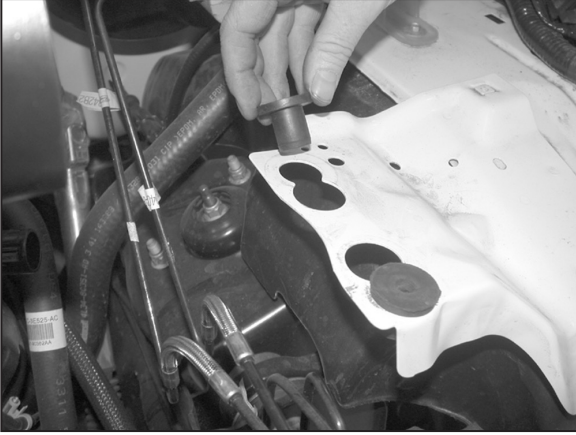

8. Install the provided nut inserts into the air box mounting holes as shown.

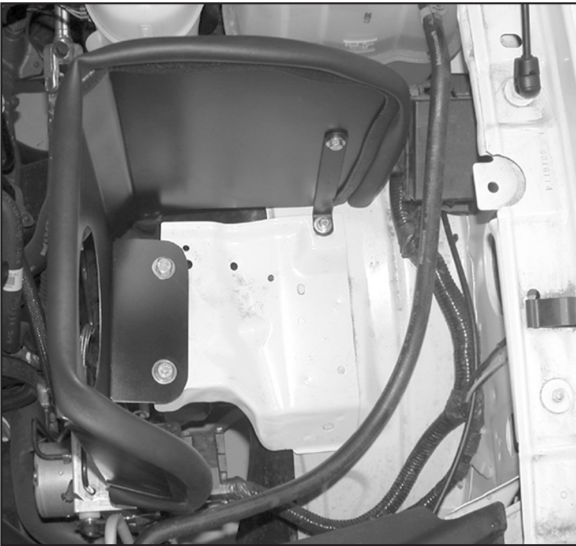

9. Install the heatshield as shown and secure with the provided hardware.



10. Open the air cleaner assembly and isolate the mass air sensor assembly.



11. Slide the rubber grommet back and disconnect the primary mass air sensor electrical connection, using a flat blade screwdriver.

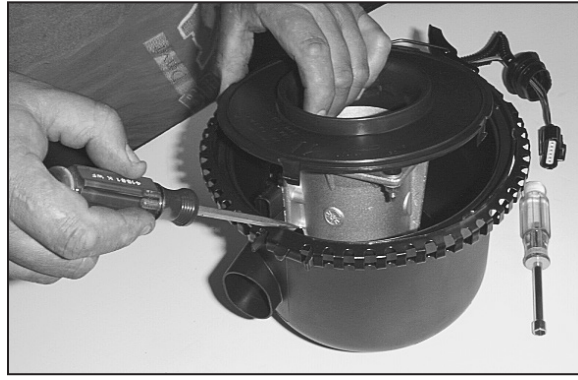

12. Using a flat blade screwdriver, push in and release the four clips that retain the mass air sensor retaining plate.

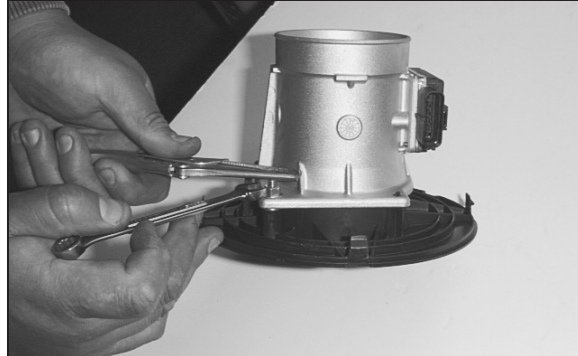

13. Using a pair of small vise grips or pliers, hold the stud while using a 10mm wrench to loosen the nuts, then remove the mass air sensor from the retaining plate.

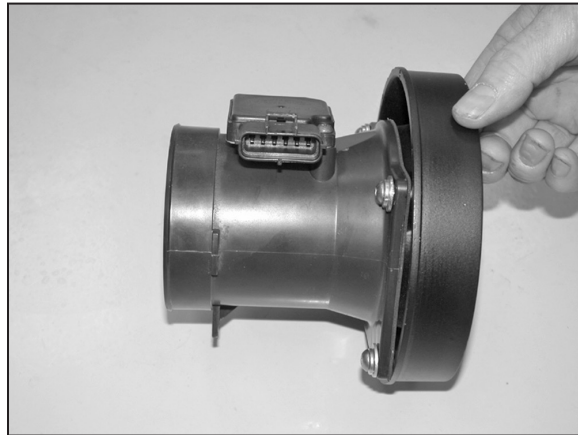

14. Attach the mass air adapter to the mass air sensor using the gasket and hardware provided as shown.



15. Install silicone hose (08724) onto the throttle body with the provided hose clamp as shown.



16. Install the tube mounting bracket (07198) onto the 8mm stud protruding from the engine with two flat washers and 8mm nut provided.

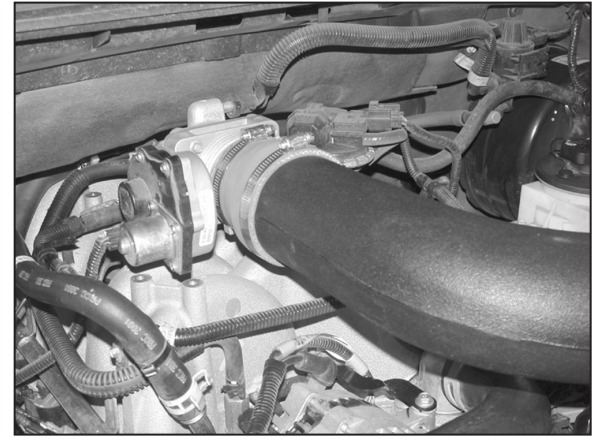

17. Install the K&N® intake tube into the silicone hose on the throttle body and secure with the provided hose clamp.

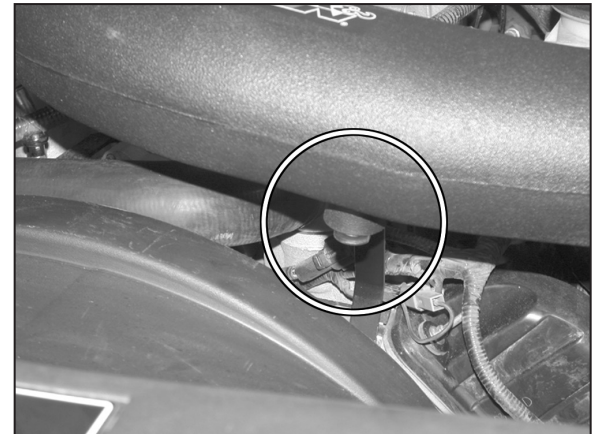

18. Attach the K&N® intake tube to the tube mounting bracket with the provided hardware.

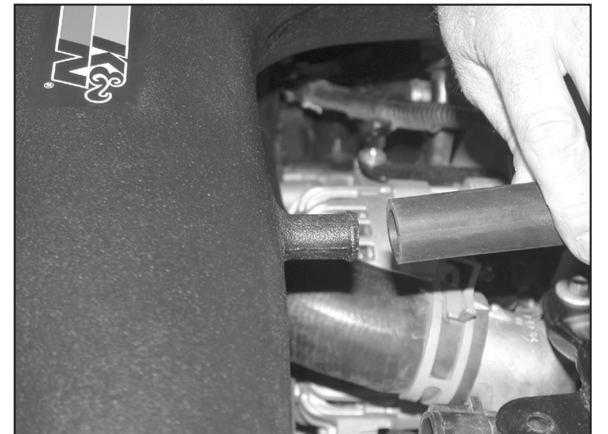

19. Install the provided silicone vent hose onto the valve cover and onto the K&N® intake tube as shown.

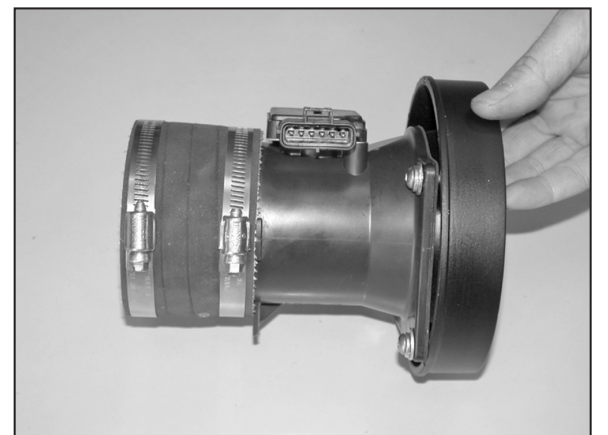

20. Install the provided silicone hose (08626) onto the mass air assembly and secure with the provided hose clamp.

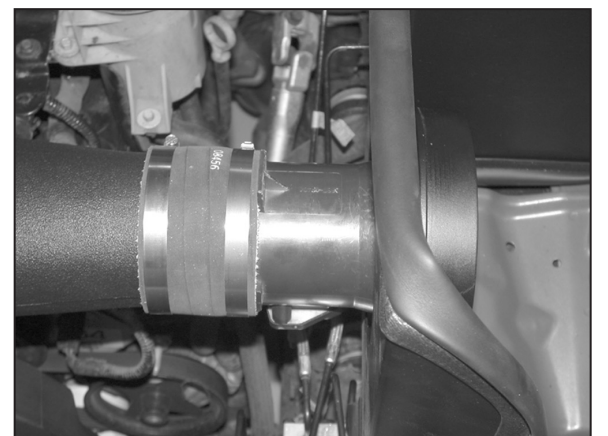

21. Install the mass air sensor assembly onto the K&N® intake tube and secure with the provided hose clamp.

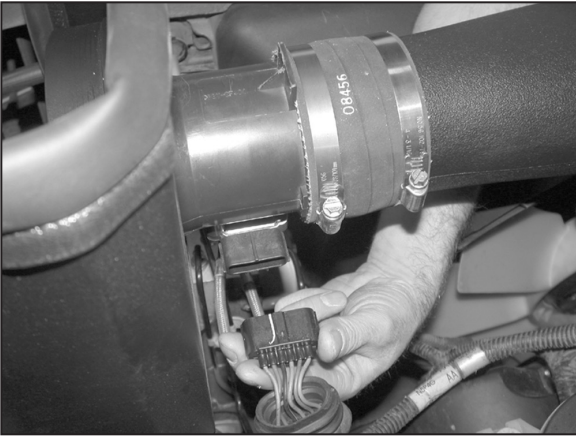

22. Reconnect the primary and secondary mass air sensor electrical connections.

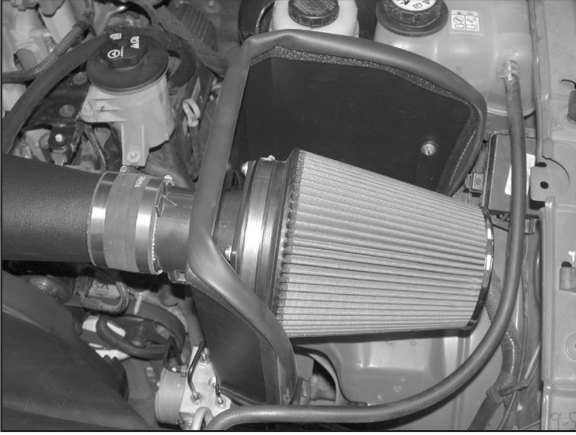

23. Install the K&N® air filter and secure with provided hose clamp.



24. Reconnect the vehicle's negative battery cable. Double check to make sure everything is tight and properly positioned before starting the vehicle.

25. The C.A.R.B. exemption sticker, (attached), must be visible under the hood so that an emissions inspector can see it when the vehicle is required to be tested for emissions. California requires testing every two years, other states may vary.

26. It will be necessary for all K&N® high flow intake systems to be checked periodically for realignment, clearance and tightening of all connections. Failure to follow the above instructions or proper maintenance may void warranty.

ROAD TESTING:

1. Start the engine with the transmission in neutral or park, and the parking brake engaged. Listen for air leaks or odd noises. For air leaks secure hoses and connections. For odd noises, find cause and repair before proceeding. This kit will function identically to the factory system except for being louder and much more responsive.

2. Test drive the vehicle. Listen for odd noises or rattles and fix as necessary.

3. If road test is fine, you can now enjoy the added power and performance from your kit.

4. K&N Engineering, Inc., requires cleaning the intake system's air filter element every 100,000 miles. When used in dusty or off-road environments, our filters will require cleaning more often. We recommend that you visually inspect your filter once every 25,000 miles to determine if the screen is still visible. When the screen is no longer visible some place on the filter element, it is time to clean it. To clean and re-oil, purchase our filter Recharger® service kit, part number 99-5050 or 99-5000 and follow the easy instructions.

INTAKE SYSTEMS FOR VEHICLES LISTED ARE 50 STATE LEGAL. SEE KNFILTERS.COM FOR CARB STATUS ON EACH PART FOR A SPECIFIC VEHICLE.