



INTAKE SYSTEMS FOR VEHICLES LISTED ARE 50 STATE LEGAL. SEE KNFILTERS.COM FOR CARB STATUS ON EACH PART FOR A SPECIFIC VEHICLE.

# INSTALLATION INSTRUCTIONS

57-1517-2

DODGE

2000 Durango

V8-5.2L

2000-03 Dakota / Durango

V8-5.9L

NOTE: This kit was not designed to fit vehicles with a body lift.

### TOOLS NEEDED:

- Ratchet
- Long Extension
- 13mm Socket
- Pliers
- 1" Wrench
- 10mm Wrench
- Flat Blade Screwdriver
- 5mm Allen Wrench
- 4mm Allen Wrench
- 1/8" Allen Wrench
- 5/8" Wrench

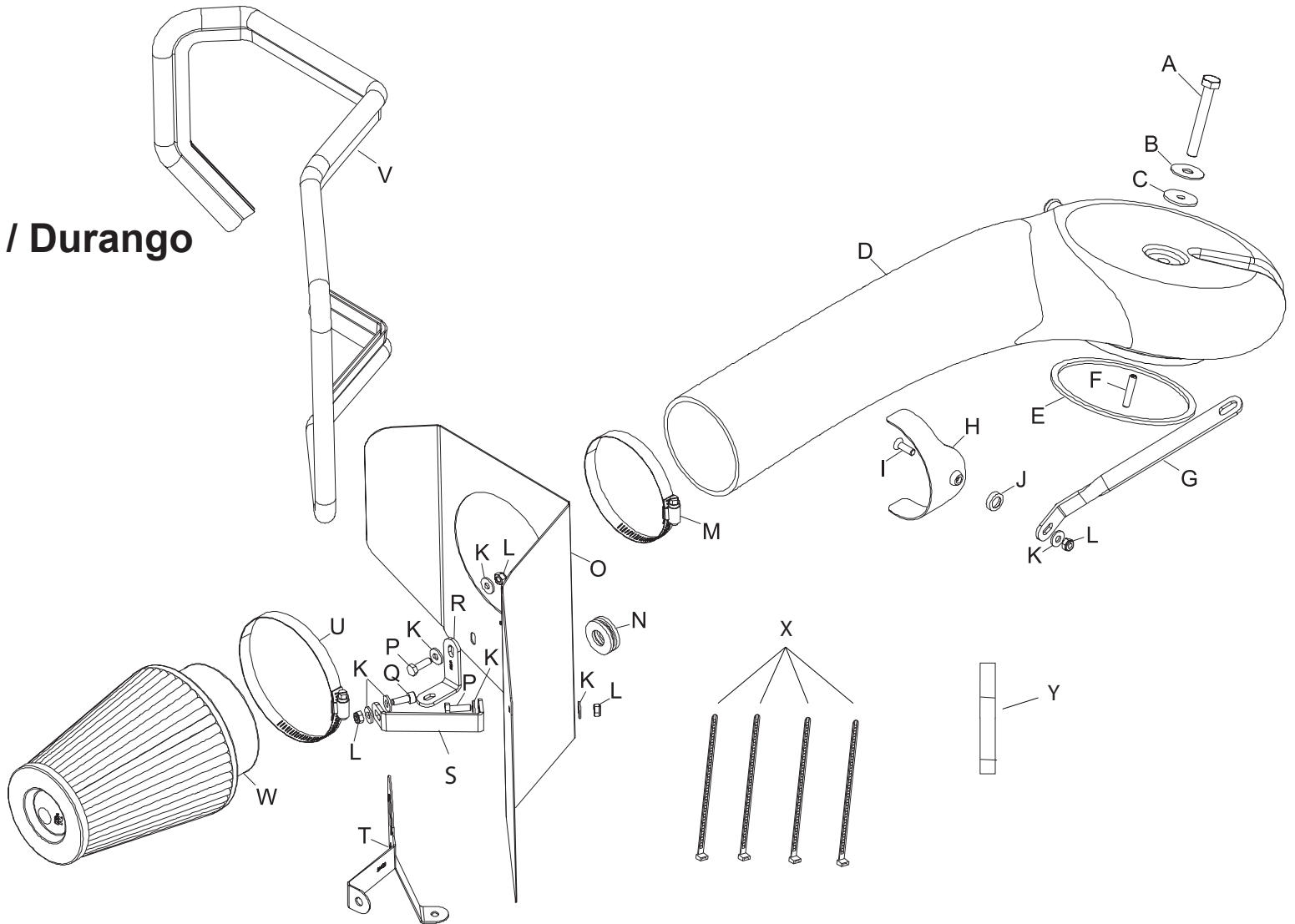

### PARTS LIST:

Description	Qty.	Part #	Description	Qty.	Part #	Description	Qty.	Part #
A Nut Extension 1/4"-20x2.84	1	08241	J Washer, Conical, Nylon,	1	08180	S Bracket Long "C"	1	070682
B Washer 1.25 0Dx.40ID	1	08126	K Washer 1/4"ID x 5/8"OD	7	08275	T Bracket Cruise Control	1	26521
C Washer 1.25 0Dx.30ID-Rub.	1	21708	L Nut 6mm Nylock	4	07553	U Hose Clamp #64	1	08648
D Intake Tube	1	087141	M Hose Clamp #60	1	08624	V Edge Trim 56" L	1	102490
E Gasket 4BBL Carb.	1	09989	N Grommet	1	08053	W Air Filter	1	RC-4680
F Screw 1/4"-20x11/2 L Set	1	07800	O Heat Shield	1	07436	X Cable tie	4	21591
G Bracket, Twist	1	070840	P Bolt 6mm-1.00x20mm	2	07865	Y Thread Locker	1	482
H Bracket, Saddle	1	078855	Q Bolt 6mm-1.00x16mm Allen	1	07818			
I Bolt 6mm-1.00x20mm F/H/A	1	08376	R Bracket "L" Bend	1	26517			

**NOTE: FAILURE TO FOLLOW INSTALLATION INSTRUCTIONS AND NOT USING THE PROVIDED HARDWARE MAY DAMAGE THE INTAKE TUBE, THROTTLE BODY AND ENGINE.**

### TO START:

1. Turn off the ignition and disconnect the negative battery cable.

**NOTE: Disconnecting the negative battery cable erases pre-programmed electronic memories. Write down all memory settings before disconnecting the negative battery cable. Some radios will require an anti-theft code to be entered after the battery is reconnected. The anti-theft code is typically supplied with your owner's manual. In the event your vehicles anti-theft code cannot be recovered, contact an authorized dealership to obtain your vehicles anti-theft code.**



2. Loosen and remove the plenum retaining nut.

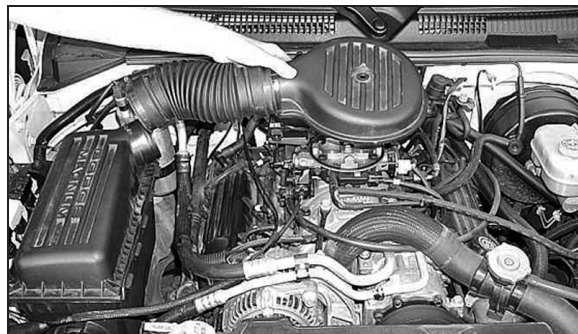

3. Disconnect the crankcase vent line from the factory plenum, then loosen the hose clamp on the air box flange to remove the plenum/bellows assembly.



4. Loosen and remove the nut that secures the air box to the inner fender, then pull firmly upward to release the air box from its mounting grommets and remove the air box assembly. **NOTE: K&N recommends that you do not discard your factory air intake.**

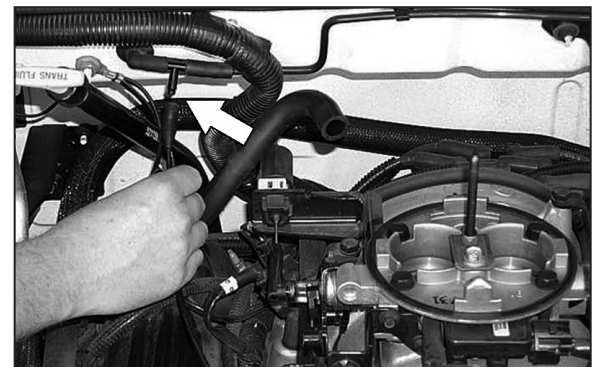

5. Remove the cruise control vacuum line from the vacuum tee on the firewall.

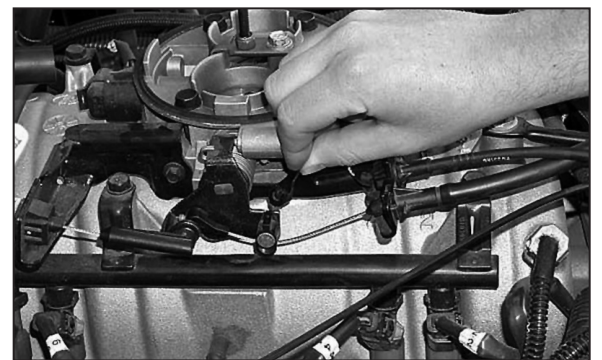

6. Remove the cruise control cable at the throttle body. **NOTE: Slide the cable end off the throttle post by pushing the cable end towards the firewall.**



7. Using a pair of pliers, squeeze the release tabs on the cruise control cable, then pull the cable out of the retaining bracket.

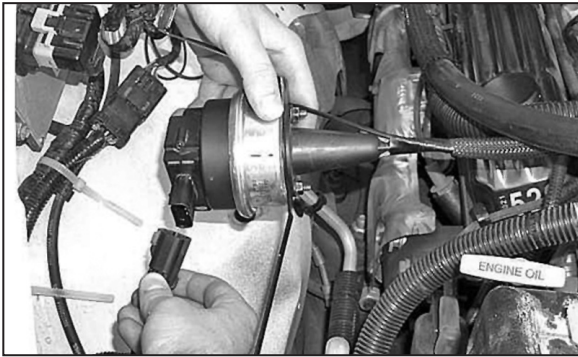

8. Loosen and remove the three nuts that secure the cruise control bracket, then pull the cruise control assembly upwards to disconnect the cruise control electrical connection as shown.

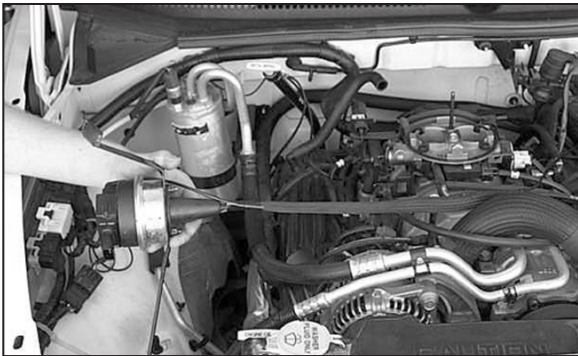

9. Remove the complete cruise control assembly.

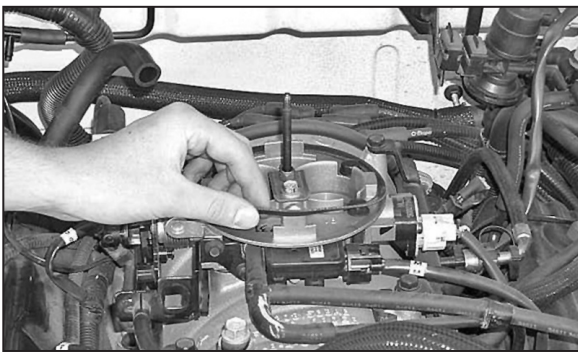

10. Remove the throttle body gasket as shown.

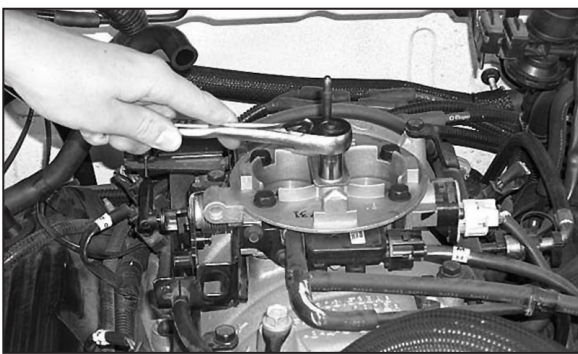

11. Loosen and remove the bolt that secures the stud/bracket assembly as shown.

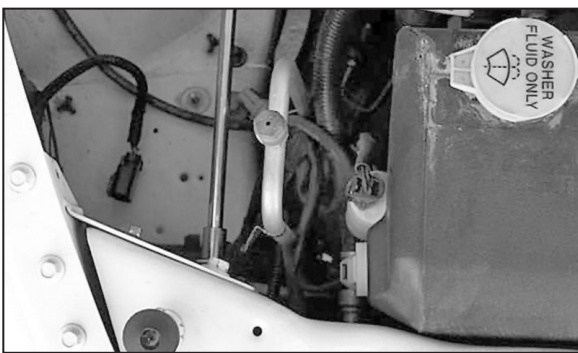

12. Loosen and remove the bolt that secures the inner fender to the radiator core support.

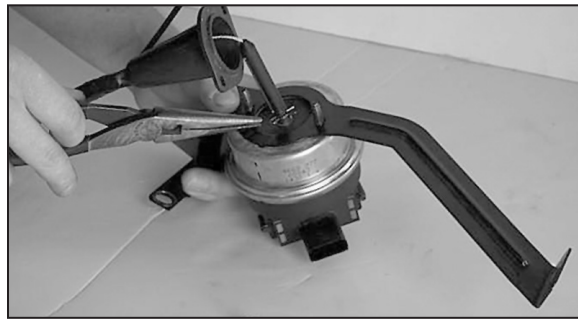

13. Loosen and remove the two nuts that secure the cruise control actuator to the bracket, then slide the diaphragm cover upwards and remove the pin from the cable end.



14. Remove the original cruise control bracket and replace it with the provided bracket as shown.

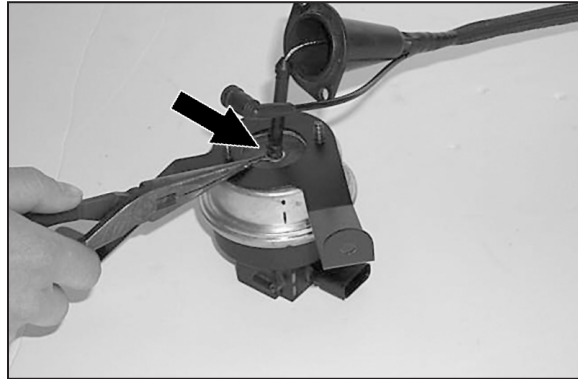

15. Slide the cable end back onto the actuator shaft and reinstall the pin as shown.



16. Using the original nuts secure the cover to the cruise control assembly, as shown.  
**NOTE: Also reconnect the vacuum line to the cruise control assembly.**

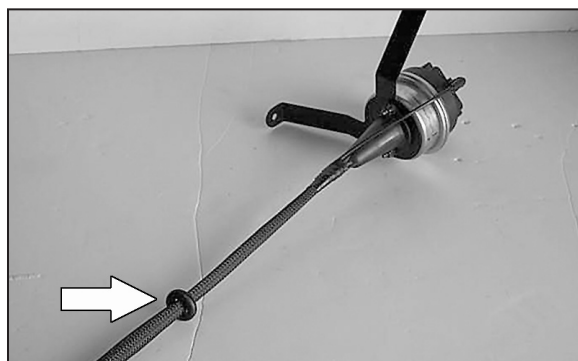

17. Slide the provided grommet over the cable ends as shown.



18. Position the cruise control into the vehicle in order to reconnect the cruise control electrical connection as shown.

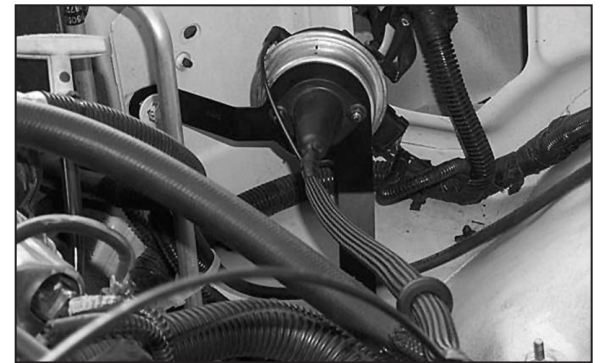

19. Using one of the nuts removed in step #8, and the bolt removed in step #12, secure the cruise control assembly as shown.

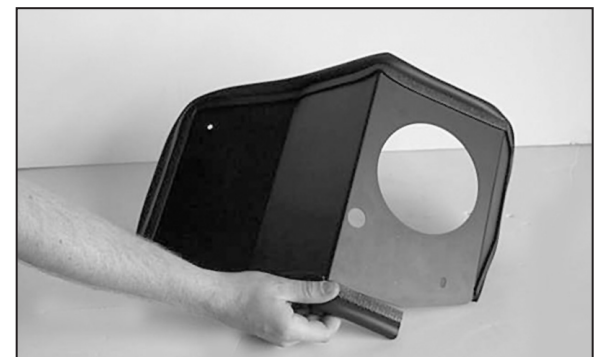

20. Apply the edge trim to the heat shield and trim to fit as shown.



21. Secure the "L" and "C" brackets to the heat shield with the hardware provided as shown.  
**DO NOT TIGHTEN COMPLETELY.**



22. Position the heat shield into the vehicle and feed the cruise control cable and vacuum line through the small hole in the heat shield, then place the grommet into the hole in the heat shield.

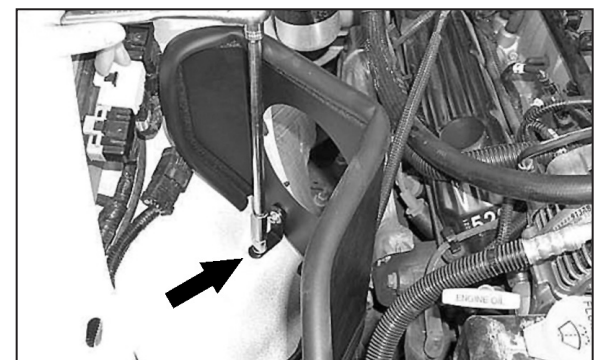

23. Install the heat shield and secure the "L" bracket to the air box mounting stud using the hardware provided as shown.  
**DO NOT TIGHTEN COMPLETELY.**



24. Attach the "C" bracket to the inner fender flange with the hardware provided as shown.  
**DO NOT TIGHTEN COMPLETELY.**



25. Reconnect the cruise control vacuum line as shown.

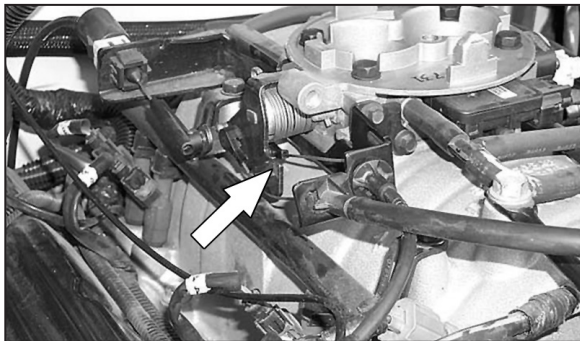

26. Slide the cruise control cable through the cable retainer and clip in place, then reconnect the cable end onto the throttle post as shown.

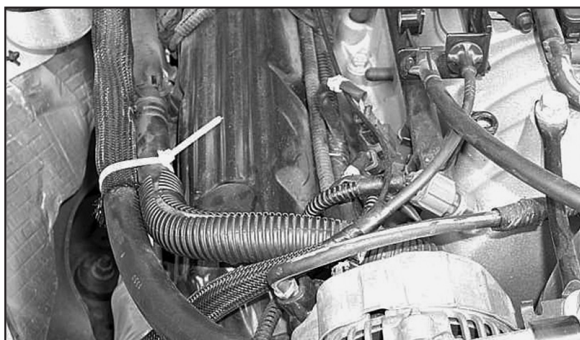

27. Using one of the provided zip ties, secure the A/C line and heater hose together as shown. **NOTE: when installing the K&N® intake tube, check the two hoses for clearance under the intake tube and adjust for best fit.**

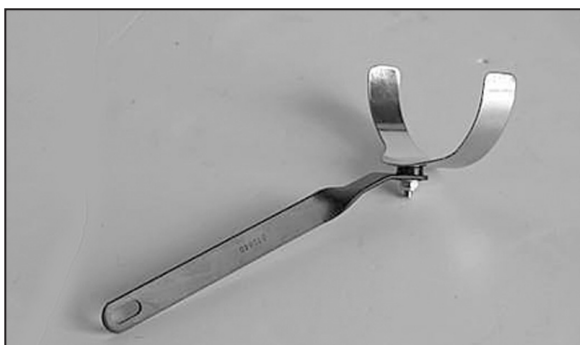

28. Assemble the saddle bracket assembly as shown.

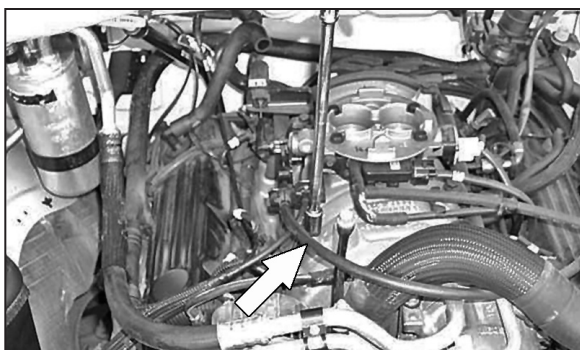

29. Loosen and remove the bolt that retains the fuel rail bracket.



30. Install the saddle bracket assembly using the bolt removed in step #28. **DO NOT TIGHTEN COMPLETELY.**

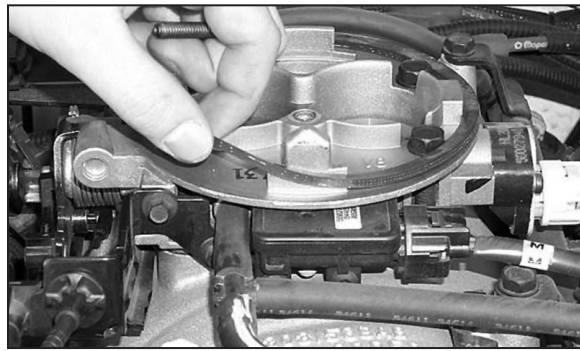

31. Apply the new provided gasket on the throttle body as shown.

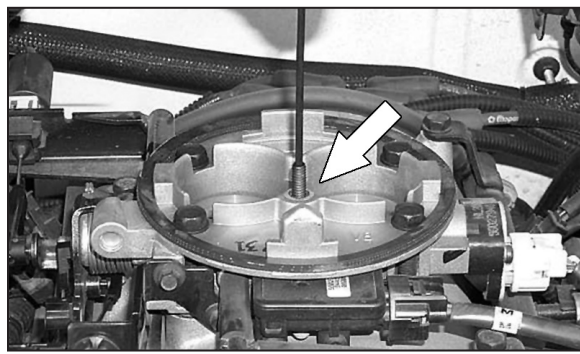

32. Install the provided stud into the throttle body as shown. **NOTE: Apply two drops of thread locker to the throttle body stud. Failure to follow the above instructions may damage the throttle body.**



33. Slide the K&N® intake tube through the hole in the heat shield as shown.



34. Install the K&N® intake tube onto the throttle body and secure the plenum with the provided nut extension, and washer.

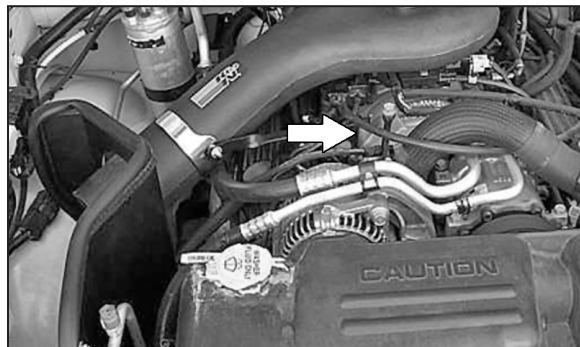

35. Secure the saddle bracket to the K&N® intake tube with the provided hose clamp as shown, then tighten the bolt at the fuel rail (see arrow). Position the heat shield for best fit and clearance.

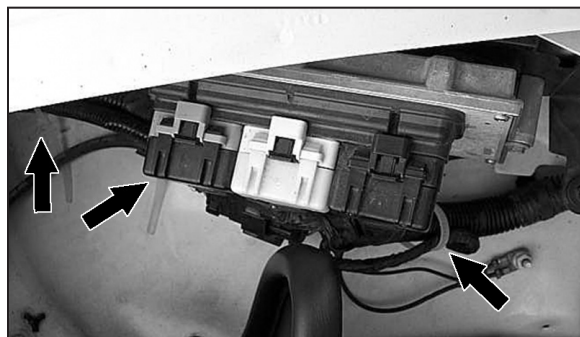

36. Using the provided zip-ties, secure the wire harness as shown.



37. Install the K&N® Air Filter and secure with the provided hose clamp.

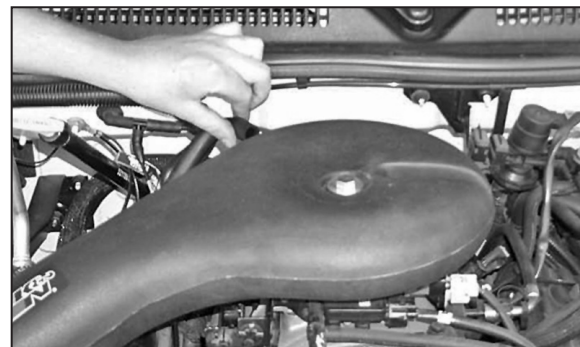

38. Reconnect the crankcase vent line to the K&N® intake tube as shown.

39. Reconnect the vehicle's negative battery cable. Double check to make sure everything is tight and properly positioned before starting the vehicle.

40. The C.A.R.B. exemption sticker, (attached), must be visible under the hood so that an emissions inspector can see it when the vehicle is required to be tested for emissions. California requires testing every two years, other states may vary.

41. It will be necessary for all K&N® high flow intake systems to be checked periodically for realignment, clearance and tightening of all connections. Failure to follow the above instructions or proper maintenance may void warranty.

#### ROAD TESTING:

1. Start the engine with the transmission in neutral or park, and the parking brake engaged. Listen for air leaks or odd noises. For air leaks secure hoses and connections. For odd noises, find cause and repair before proceeding. This kit will function identically to the factory system except for being louder and much more responsive.

2. Test drive the vehicle. Listen for odd noises or rattles and fix as necessary.

3. If road test is fine, you can now enjoy the added power and performance from your kit.

4. K&N Engineering, Inc., requires cleaning the intake system's air filter element every 100,000 miles. When used in dusty or off-road environments, our filters will require cleaning more often. We recommend that you visually inspect your filter once every 25,000 miles to determine if the screen is still visible. When the screen is no longer visible some place on the filter element, it is time to clean it. To clean and re-oil, purchase our filter Recharger® service kit, part number 99-5050 or 99-5000 and follow the easy instructions.

**INTAKE SYSTEMS FOR VEHICLES LISTED ARE 50 STATE LEGAL. SEE KNFILTERS.COM FOR CARB STATUS ON EACH PART FOR A SPECIFIC VEHICLE.**